

# Back to School



# PRICE LIST

2016-10

**e-print**  
[www.e-print.com.hk](http://www.e-print.com.hk)

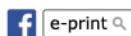

# Content

Business Cards .....	P.03
Leaflets .....	P.04
Posters .....	P.07
Parallel Fold Long Leaflets .....	P.08
Booklets – Single / Full Colour Covers .....	P.10
Booklets – Saddle Stitching Binding .....	P.12
Booklets – Perfect Binding .....	P.16
Booklets – Sewn Perfect Binding .....	P.20
Notebooks .....	P.24
Paper Placemats .....	P.26
<b>New</b> Calendars .....	P.27
Red Packet .....	P.32
<b>New</b> Fai Chun .....	P.34
<b>New</b> Wedding Cards .....	P.36
Full Colour Envelopes / Letterheads .....	P.40
Spot Colour Envelopes / Letterheads .....	P.42
Full Colour Document Envelopes .....	P.44
NCR Invoices / Receipt Booklets .....	P.46
Full Colour Coupons / Tickets .....	P.54
Special Labels .....	P.56
Full Colour Labels / Stickers .....	P.58
Plastic Folders .....	P.59
Full Colour Paper Folders .....	P.62
Paper Bags .....	P.66
<b>New</b> Kraft Paper Bags .....	P.67
Non Woven Bags .....	P.68
Pre-ink Stamps .....	P.69
<b>New</b> Promotional Fan .....	P.70
Hardcover Menu .....	P.72
Crystal Trophies .....	P.74
Digital Printing Colour Leaflets .....	P.76
Digital Fancy Cards .....	P.77
Digital Fancy Greeting Cards .....	P.78
Digital Printing Colour Menus .....	P.80
Digital Printing Colour Booklets .....	P.82
Digital Printing Notebooks .....	P.90
Photobook 1010 .....	P.92
Finishing Items .....	P.95

## Business Cards

### Matt Lamination Card / Offset Printing White Woodfree Card / Card with Spot UV

Qty. / Type	Matt Laminated Card (250g Double-sided Coated Art Paper)	White Woodfree Card (260g White Woodfree Card)	Card with Spot UV (250g Double-sided Coated Art Paper)
100 pcs	\$45	\$50	\$80
200 pcs	\$55	\$60	\$90
300 pcs	\$55	\$70	\$100
500 pcs	\$65	\$90	\$140
1,000 pcs	\$95	\$140	\$240

- Prices above are calculated with standard size (90 x 54mm)
- Prices of business cards with non-standard size, are calculated by the portion of measure area of standard size (90 x 54mm)
- Every package of 100 pcs business card using co-publish printing method, its quantity may occur a variance of  $\pm 5\%$  (Please note that under no circumstance should refund or reimbursement be accepted in terms of such issue)
- Delivery fee of business cards starts at \$15

**Lead Time:** 1 working day (Matt Laminated Card, White Woodfree Card)  
2 working days (Card with Spot UV)  
(Except for items with finishing, start from the date when customers confirm the proof)

### Finishing (Business Card)

Finishing Items	Prices	Remarks
<b>Creasing / Perforation</b>	+\$10 / 100 pcs	1,000 pcs above, please refer to page 72
<b>Round Cornering</b>	+\$5 / 100 pcs	2,000 pcs or above, +\$4 / 100 pcs
<b>Foil Stamping (single-sided)</b>	+\$40 / 100 pcs	+\$20 / 100 pcs, after first 100 pcs (Double-sided x 2)
<b>Embossing (single-sided)</b>	+\$70 / 100 pcs	+\$20 / 100 pcs, after first 100 pcs (Double-sided x 2)

- For Creasing / Perforation / Foil Stamping / Embossing, paper size is restricted within 90 x 108mm or 180 x 54mm

**Lead Time (Finishing):** Die Cut: + 2 working days (Complicated Die-Cutter: + 3 working days)  
Rounded Corner: + 1 working day  
Foil Stamping / Embossing: Headquarter + 2 working days (After 3 pm),  
Branches + 3 working days (After 10 am)  
Hole Drilling: + 1 working day  
Creasing: + 1 working day  
Perforation: + 1 working day

Note: Please be aware that all the prices are subject to change without prior notice, please visit our website for the latest updates

## 128g Gloss Art Paper

A5 (4C + 0 / 4C + 4C)	
Qty.	Price
600 pcs	\$290
1,000 pcs	\$340
2,000 pcs	\$390
3,000 pcs	\$590
4,000 pcs	\$590
6,000 pcs	\$740
20,000 pcs	\$1,440

Colour Qty.	A4		A3	
	4C + 0	4C + 4C	4C + 0	4C + 4C
300 pcs	\$290		\$450	\$550
500 pcs	\$340		\$500	\$600
1,000 pcs	\$390		\$600	\$700
1,500 pcs	\$590		\$850	\$950
2,000 pcs	\$590		\$850	\$950
3,000 pcs	\$740		\$1,050	\$1,150
10,000 pcs	\$1,440		\$2,350	\$2,450

Print Matter Sealing Service is now available. Please refer to "Finishing items" for details.

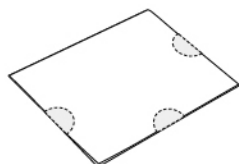

3 Labels

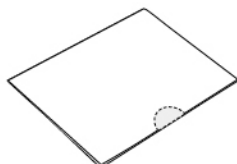

1 Label

## Leaflets Full Colour Leaflets

### 157g Gloss Art Paper

A5 (4C + 4C)	
Qty.	Price
600 pcs	\$300
1,000 pcs	\$350
2,000 pcs	\$400
3,000 pcs	\$610
4,000 pcs	\$610
6,000 pcs	\$770
20,000 pcs	\$1,540

Colour Qty.	A4		A3	
	4C + 0	4C + 4C	4C + 0	4C + 4C
300 pcs	\$300		\$470	\$570
500 pcs	\$350		\$520	\$620
1,000 pcs	\$400		\$620	\$720
1,500 pcs	\$610		\$890	\$990
2,000 pcs	\$610		\$890	\$990
3,000 pcs	\$770		\$1,110	\$1,210
10,000 pcs	\$1,540		\$2,550	\$2,650

- For 80g Woodfree Paper and 128g Matt Art Paper, the minimum order quantity begins at 2,000 pcs (For A4 size), please refer to the price list of 128g Gloss Art Paper for further details
- For 100g Woodfree Paper, the minimum order quantity begins at 1,000 pcs, please refer to the price list of 128g Gloss Art Paper for further details
- For 120g, 140g Woodfree Paper and 157g Matt Art Paper, the minimum order quantity begins at 2,000 pcs, please refer to the price list of 157g Gloss Art Paper for further details

**Lead Time:** 1 working day (128g, 157g Gloss Art Paper; 80g, 100g, 120g Woodfree paper)  
(Except for items with finishing, start from the date when customers confirm the proof)

Note: Please be aware that all the prices are subject to change without prior notice, please visit our website for the latest updates

## Leaflets

### Full Colour Leaflets

#### 210 / 250g Gloss Art Paper

Colour Qty.	A4 / A5		A3	
	4C + 0	4C + 4C	4C + 0	4C + 4C
1,000 pcs	\$740	\$940	\$900	\$1,150
1,500 pcs	\$940	\$1,140	\$1,450	\$1,750
2,000 pcs	\$940	\$1,140	\$1,450	\$1,750
3,000 pcs	\$1,340	\$1,540	\$1,800	\$2,100
10,000 pcs	\$2,740	\$2,940	\$4,850	\$5,050

If other paper materials are needed, please contact us for details, lead time is around 3 days normally

#### 300g Gloss Art Paper

Colour Qty.	A4 / A5		A3	
	4C + 0	4C + 4C	4C + 0	4C + 4C
1,000 pcs	\$840	\$1,040	\$1,000	\$1,200
1,500 pcs	\$1,040	\$1,240	\$1,600	\$1,800
2,000 pcs	\$1,040	\$1,240	\$1,600	\$1,800
3,000 pcs	\$1,440	\$1,640	\$2,050	\$2,250
10,000 pcs	\$3,040	\$3,240	\$5,500	\$5,700

Lead Time: 2 working days (210g, 250g, 300g Double-sided Coated Art Paper; 128g, 157g Matt Art Paper; 140g Woodfree paper)  
(Except for items with finishing, start from the date when customers confirm the proof)

## Posters

### 128g Gloss Art Paper

Colour Qty.	A2 420 x 594mm 16.5 x 23.5"	A1 594 x 840mm 23 x 33"	Extra Large A1 660 x 965mm 26 x 38"
	4C + 0	4C + 0	4C + 0
10 pcs	\$450	\$800	\$1,050
50 pcs	\$500	\$900	\$1,150
100 pcs	\$550	\$1,100	\$1,250
200 pcs	\$600	\$1,200	\$1,350
300 pcs	\$650	\$1,250	\$1,450
400 pcs	\$650	\$1,300	\$1,550
500 pcs	\$700	\$1,350	\$1,700

### 157g Gloss Art Paper

Colour Qty.	A2 420 x 594mm 16.5 x 23.5"	A1 594 x 840mm 23 x 33"	Extra Large A1 660 x 965mm 26 x 38"
	4C + 0	4C + 0	4C + 0
10 pcs	\$490	\$880	\$1,140
50 pcs	\$540	\$980	\$1,240
100 pcs	\$590	\$1,180	\$1,340
200 pcs	\$640	\$1,280	\$1,440
300 pcs	\$690	\$1,330	\$1,540
400 pcs	\$690	\$1,380	\$1,640
500 pcs	\$740	\$1,430	\$1,790

Lead Time: 1 working day (128g, 157g Gloss Art Paper; 80g, 100g, 120g Woodfree paper)  
2 working days (210g, 250g, 300g Double-sided Coated Art Paper; 128g, 157g Matt Art Paper; 140g Woodfree paper)  
(Except for items with finishing, start from the date when customers confirm the proof)

Note: Please be aware that all the prices are subject to change without prior notice, please visit our website for the latest updates  
If finishing items are needed, please refer to page 95-109 for further details

## Model A

630 x 297mm / 25 x 12"						
Qty.	Type	128g	157g	Letter / 6PP Accordion Fold	8PP Roll Fold	Letter + Half Fold / 6PP Accordion + Half Fold
300 pcs		\$1,410	\$1,500	For the folding price, please refer to page 80 for the price of A1 folding in the finishing items category.		
500 pcs		\$1,470	\$1,550			
1,000 pcs		\$1,670	\$1,800			
2,000 pcs		\$1,990	\$2,150			
3,000 pcs		\$2,360	\$2,600			
4,000 pcs		\$2,750	\$3,050			
5,000 pcs		\$3,280	\$3,650			
6,000 pcs		\$3,720	\$4,400			
7,000 pcs		\$4,090	\$4,850			
8,000 pcs		\$4,350	\$5,150			
9,000 pcs		\$5,050	\$5,900			
10,000 pcs		\$5,250	\$6,250			

- Only double-sided lamination is available for products using 128g Gloss Art Paper, as 128g Gloss Art Paper with single-sided lamination may lead to rolls at its edge
- If other paper materials are needed, please contact us for details, lead time is around 3 days normally

**Lead Time:** 2 working days (128g, 157g Gloss Art Paper; 80g, 100g, 120g Woodfree paper)  
 3 working days (210g, 250g, 300g Double-sided Coated Art Paper; 128g, 157g)  
 Matt Art Paper; 140g Woodfree paper)  
 (Except for items with finishing, start from the date when customers confirm the proof)

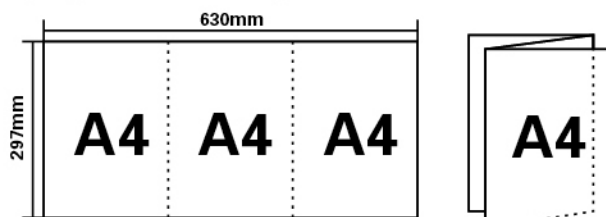

Accordion Fold

## Parallel Fold Long Leaflets

### Model B

840 x 297mm / 33 x 12"					
Qty.	Type	128g	157g	Gatefold	Double Gatefold
300 pcs		\$1,870	\$2,100	For the folding price, please refer to page 80 for the price of A1 folding in the finishing items category.	
500 pcs		\$1,920	\$2,200		
1,000 pcs		\$2,050	\$2,350		
2,000 pcs		\$2,430	\$2,800		
3,000 pcs		\$2,800	\$3,250		
4,000 pcs		\$3,070	\$3,600		
5,000 pcs		\$3,450	\$4,040		
6,000 pcs		\$3,720	\$4,400		
7,000 pcs		\$4,090	\$4,850		
8,000 pcs		\$4,350	\$5,150		
9,000 pcs		\$5,050	\$5,900		
10,000 pcs		\$5,250	\$6,250		

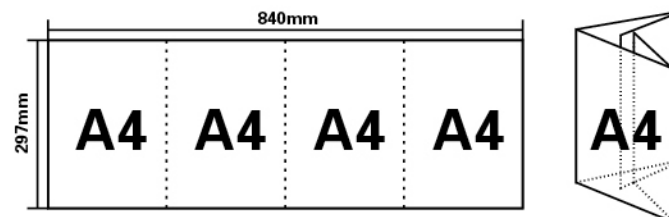

Double Gatefold

Note: Please be aware that all the prices are subject to change without prior notice, please visit our website for the latest updates  
 If finishing items are needed, please refer to page 95-109 for further details

## A4 Upright Orientated Saddle Stitching Booklet – Cover

Qty. Type	100 pcs	300 pcs	500 pcs	1,000 pcs	2,000 pcs	3,000 pcs	4,000 pcs	5,000 pcs
<b>210g</b>	\$1,080	\$1,140	\$1,250	\$1,420	\$2,280	\$2,910	\$3,400	\$3,900
<b>250g</b>	\$1,110	\$1,200	\$1,300	\$1,530	\$2,460	\$3,060	\$3,600	\$4,150
<b>300g</b>	\$1,140	\$1,260	\$1,360	\$1,620	\$2,640	\$3,330	\$3,960	\$4,600

## A5 Upright Orientated Saddle Stitching Booklet – Cover

Qty. Type	100 pcs	300 pcs	500 pcs	1,000 pcs	2,000 pcs	3,000 pcs	4,000 pcs	5,000 pcs
<b>210g</b>	\$1,060	\$1,110	\$1,150	\$1,260	\$1,500	\$2,070	\$2,280	\$2,650
<b>250g</b>	\$1,090	\$1,140	\$1,190	\$1,320	\$1,600	\$2,160	\$2,400	\$2,800
<b>300g</b>	\$1,110	\$1,170	\$1,240	\$1,400	\$1,700	\$2,310	\$2,600	\$3,000

## A4 Upright Orientated Perfect Binding Booklet – Cover

Qty. Type	100 pcs	300 pcs	500 pcs	1,000 pcs	2,000 pcs	3,000 pcs	4,000 pcs	5,000 pcs
<b>210g</b>	\$1,080	\$1,170	\$1,250	\$1,450	\$2,340	\$3,000	\$3,560	\$4,100
<b>250g</b>	\$1,110	\$1,200	\$1,310	\$1,560	\$2,520	\$3,150	\$3,760	\$4,350
<b>300g</b>	\$1,140	\$1,260	\$1,370	\$1,650	\$2,700	\$3,450	\$4,120	\$4,750

## A5 Upright Orientated Perfect Binding Booklet – Cover

Qty. Type	100 pcs	300 pcs	500 pcs	1,000 pcs	2,000 pcs	3,000 pcs	4,000 pcs	5,000 pcs
<b>210g</b>	\$1,070	\$1,110	\$1,170	\$1,290	\$1,560	\$2,160	\$2,440	\$2,800
<b>250g</b>	\$1,090	\$1,140	\$1,200	\$1,350	\$1,640	\$2,250	\$2,560	\$2,950
<b>300g</b>	\$1,110	\$1,170	\$1,250	\$1,420	\$1,760	\$2,400	\$2,720	\$3,150

## Booklets Single / Full Colour Cover

### A4 Cover with Single-Sided Lamination

Qty. Type	100 pcs	300 pcs	500 pcs	1,000 pcs	2,000 pcs	3,000 pcs	4,000 pcs	5,000 pcs
<b>Matt</b>	\$400	\$400	\$400	\$400	\$530	\$790	\$1,050	\$1,310
<b>Gloss</b>	\$200	\$200	\$200	\$200	\$330	\$490	\$660	\$820

### A5 Cover with Single-Sided Lamination

Qty. Type	100 pcs	300 pcs	500 pcs	1,000 pcs	2,000 pcs	3,000 pcs	4,000 pcs	5,000 pcs
<b>Matt</b>	\$400	\$400	\$400	\$400	\$400	\$400	\$530	\$660
<b>Gloss</b>	\$200	\$200	\$200	\$200	\$200	\$250	\$330	\$410

### A4 / A5 Cover with Single-Sided Matt Lamination + Spot UV

Qty. Type	100 pcs	300 pcs	500 pcs	1,000 pcs	2,000 pcs	3,000 pcs	4,000 pcs	5,000 pcs
<b>A4</b>	\$1,100	\$1,100	\$1,100	\$1,100	\$1,630	\$2,290	\$2,950	\$3,610
<b>A5</b>	\$1,100	\$1,100	\$1,100	\$1,100	\$1,500	\$1,900	\$2,430	\$2,960

- Prices above refer to printing price only. Please seek for quotations if other finishing items are needed
  - If different paper materials are used for cover and inner, total price will be price of cover + price of inner
- For example:** (A5 Size, Upright Orientated Saddle Stitching Booklet 300 pcs, Cover 4pp + Inner 28pp, Full Colour Printing, 250g cover, 128g inner)  
(Prices: \$1,140 + \$2,898 = \$4,038)

Note: Please be aware that all the prices are subject to change without prior notice, please visit our website for the latest updates

## 128g Gloss Art Paper



A4 Full Colour Inner (Upright Orientated)								
Qty. Page	100 pcs	300 pcs	500 pcs	1,000 pcs	2,000 pcs	3,000 pcs	4,000 pcs	5,000 pcs
8PP	\$1,533	\$1,638	\$1,712	\$1,995	\$2,160	\$2,880	\$3,360	\$4,000
12PP	\$2,531	\$2,615	\$2,709	\$3,077	\$3,360	\$4,050	\$4,800	\$5,600
16PP	\$2,804	\$2,993	\$3,161	\$3,539	\$3,960	\$4,590	\$5,400	\$6,350
20PP	\$3,843	\$3,969	\$4,211	\$4,746	\$5,160	\$5,760	\$6,840	\$8,000
24PP	\$4,484	\$4,599	\$4,872	\$5,544	\$6,440	\$7,080	\$8,560	\$9,950
28PP	\$4,883	\$5,072	\$5,429	\$6,237	\$7,300	\$8,340	\$9,920	\$11,950
32PP	\$4,977	\$5,324	\$5,691	\$6,500	\$7,820	\$8,790	\$10,560	\$12,300
36PP	\$5,618	\$5,765	\$5,880	\$6,605	\$8,000	\$10,020	\$11,960	\$13,950
40PP	\$6,741	\$6,867	\$7,035	\$7,676	\$9,100	\$11,370	\$13,640	\$15,950
44PP	\$7,235	\$7,371	\$7,560	\$8,411	\$10,060	\$12,630	\$15,080	\$17,600
48PP	\$7,508	\$7,655	\$7,875	\$8,547	\$10,480	\$13,110	\$15,720	\$18,250
52PP	\$7,665	\$8,064	\$8,400	\$9,261	\$11,340	\$14,340	\$17,080	\$19,900
56PP	\$9,261	\$9,513	\$9,555	\$10,353	\$12,460	\$15,660	\$18,800	\$21,900
60PP	\$9,545	\$9,765	\$10,028	\$11,078	\$13,500	\$16,920	\$20,200	\$23,550
64PP	\$9,776	\$10,049	\$10,290	\$11,246	\$13,960	\$17,430	\$20,840	\$24,300

Print Matter Sealing Service is now available. Please refer to "Finishing items" for details.

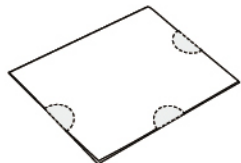

3 Labels

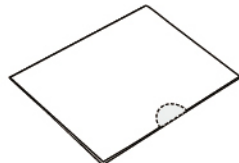

1 Label

## Booklets Full Colour Saddle Stitching Booklets

### 128g Gloss Art Paper



A5 Full Colour Inner (Upright Orientated)								
Qty. Page	100 pcs	300 pcs	500 pcs	1,000 pcs	2,000 pcs	3,000 pcs	4,000 pcs	5,000 pcs
8PP	\$945	\$1,040	\$1,134	\$1,281	\$1,440	\$1,680	\$1,920	\$2,200
12PP	\$1,397	\$1,481	\$1,659	\$1,943	\$2,040	\$2,340	\$2,880	\$3,350
16PP	\$1,512	\$1,670	\$1,796	\$2,174	\$2,260	\$3,030	\$3,800	\$4,400
20PP	\$2,132	\$2,237	\$2,415	\$2,793	\$3,020	\$3,780	\$5,040	\$5,600
24PP	\$2,457	\$2,552	\$2,835	\$3,308	\$3,600	\$4,230	\$5,320	\$6,200
28PP	\$2,793	\$2,898	\$3,077	\$3,644	\$3,920	\$5,100	\$6,360	\$7,400
32PP	\$2,930	\$3,024	\$3,140	\$3,780	\$4,140	\$5,100	\$6,360	\$7,400
36PP	\$3,276	\$3,402	\$3,570	\$4,137	\$4,800	\$6,090	\$7,280	\$8,500
40PP	\$3,539	\$3,686	\$3,791	\$4,494	\$5,140	\$6,570	\$7,800	\$9,100
44PP	\$3,896	\$4,032	\$4,095	\$4,935	\$5,900	\$7,470	\$8,840	\$10,300
48PP	\$4,788	\$4,946	\$5,093	\$5,492	\$6,360	\$8,070	\$9,680	\$11,350
52PP	\$5,093	\$5,229	\$5,387	\$6,038	\$7,080	\$8,970	\$10,800	\$12,550
56PP	\$5,334	\$5,481	\$5,639	\$6,290	\$7,420	\$9,420	\$11,320	\$13,150
60PP	\$5,639	\$5,796	\$5,933	\$6,489	\$8,080	\$10,260	\$12,240	\$14,300
64PP	\$5,639	\$5,796	\$5,933	\$6,489	\$8,080	\$10,260	\$12,240	\$14,300

- Cost of printing, zinc plate and binding charges are included in the list above which is computed with 128g Gloss Art Paper
- If lamination or other paper materials are needed for book cover, please refer to page 10-11 for further details

Lead Time: 2-3 working days

(Except for items with finishing, start from the date when customers confirm the proof)

Note: Please be aware that all the prices are subject to change without prior notice, please visit our website for the latest updates  
If finishing items are needed, please refer to page 95-109 for further details



## 128g Gloss Art Paper

A4 Single Colour Inner (Upright Orientation)								
Qty. Page	100 pcs	300 pcs	500 pcs	1,000 pcs	2,000 pcs	3,000 pcs	4,000 pcs	5,000 pcs
8PP	\$920	\$960	\$1,030	\$1,180	\$1,660	\$1,830	\$2,280	\$2,600
12PP	\$1,160	\$1,230	\$1,320	\$1,550	\$2,000	\$2,520	\$3,240	\$3,950
16PP	\$1,220	\$1,320	\$1,440	\$1,720	\$2,280	\$2,850	\$3,560	\$4,350
20PP	\$1,740	\$1,890	\$2,020	\$2,370	\$3,060	\$3,870	\$4,880	\$5,850
24PP	\$1,760	\$1,920	\$2,090	\$2,510	\$3,440	\$4,290	\$5,520	\$6,550
28PP	\$1,930	\$2,130	\$2,310	\$2,800	\$3,800	\$5,070	\$6,480	\$7,900
32PP	\$1,940	\$2,160	\$2,380	\$2,940	\$4,060	\$5,310	\$6,800	\$8,300
36PP	\$2,460	\$2,700	\$2,960	\$3,590	\$4,600	\$6,060	\$7,760	\$9,400
40PP	\$2,480	\$2,760	\$3,030	\$3,730	\$5,240	\$6,810	\$8,760	\$10,500
44PP	\$2,650	\$2,940	\$3,250	\$4,020	\$5,700	\$7,590	\$9,720	\$11,900
48PP	\$2,660	\$3,000	\$3,320	\$4,160	\$5,860	\$7,830	\$10,040	\$12,300
52PP	\$3,180	\$3,540	\$3,900	\$4,810	\$6,760	\$8,940	\$11,360	\$13,800
56PP	\$3,200	\$3,570	\$3,970	\$4,950	\$7,140	\$9,360	\$12,000	\$14,500
60PP	\$3,370	\$3,780	\$4,190	\$5,240	\$7,600	\$10,110	\$12,960	\$15,850
64PP	\$3,380	\$3,810	\$4,260	\$5,380	\$7,760	\$10,350	\$13,280	\$16,250

Print Matter Sealing Service is now available. Please refer to "Finishing items" for details.

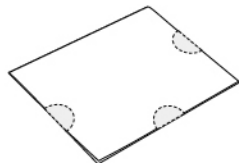

3 Labels

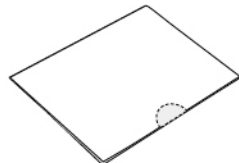

1 Label

## Booklets Single Colour Saddle Stitching Booklets

### 128g Gloss Art Paper

A5 Single Colour Inner (Upright Orientation)								
Qty. Page	100 pcs	300 pcs	500 pcs	1,000 pcs	2,000 pcs	3,000 pcs	4,000 pcs	5,000 pcs
8PP	\$690	\$720	\$740	\$820	\$1,260	\$1,410	\$1,640	\$1,900
12PP	\$820	\$870	\$900	\$1,010	\$1,520	\$1,740	\$2,240	\$2,550
16PP	\$920	\$960	\$1,030	\$1,180	\$1,660	\$1,830	\$2,280	\$2,600
20PP	\$1,050	\$1,140	\$1,190	\$1,380	\$2,240	\$2,640	\$3,280	\$3,750
24PP	\$1,160	\$1,230	\$1,320	\$1,550	\$2,440	\$2,850	\$3,560	\$4,100
28PP	\$1,290	\$1,380	\$1,480	\$1,740	\$2,680	\$3,240	\$4,160	\$4,750
32PP	\$1,580	\$1,680	\$1,800	\$2,080	\$2,800	\$3,270	\$4,200	\$4,800
36PP	\$1,730	\$1,860	\$1,980	\$2,300	\$2,960	\$3,840	\$4,840	\$5,800
40PP	\$1,740	\$1,890	\$2,020	\$2,370	\$3,080	\$4,050	\$5,120	\$6,150
44PP	\$2,110	\$2,250	\$2,400	\$2,800	\$3,960	\$4,770	\$6,120	\$6,950
48PP	\$2,120	\$2,280	\$2,450	\$2,870	\$3,980	\$4,800	\$6,160	\$7,000
52PP	\$2,270	\$2,460	\$2,650	\$3,090	\$4,220	\$5,370	\$6,760	\$8,000
56PP	\$2,280	\$2,490	\$2,700	\$3,160	\$4,360	\$5,580	\$7,040	\$8,350
60PP	\$2,650	\$2,850	\$3,050	\$3,590	\$5,220	\$6,300	\$8,040	\$9,150
64PP	\$2,660	\$2,880	\$3,100	\$3,660	\$5,240	\$6,330	\$8,080	\$9,200

- Cost of printing, zinc plate and binding charges are included in the list above which is computed with 128g Gloss Art Paper
- If lamination or other paper materials are needed for book cover, please refer to page 10-11 for further details

Lead Time: 2-3 working days

(Except for items with finishing, start from the date when customers confirm the proof)

Note: Please be aware that all the prices are subject to change without prior notice, please visit our website for the latest updates  
If finishing items are needed, please refer to page 95-109 for further details

## 128g Gloss Art Paper



A4 Full Colour Inner (Upright Orientation)								
Qty. Page	100 pcs	300 pcs	500 pcs	1,000 pcs	2,000 pcs	3,000 pcs	4,000 pcs	5,000 pcs
32PP	\$4,977	\$5,324	\$5,691	\$6,500	\$7,430	\$8,790	\$10,560	\$12,300
36PP	\$5,618	\$5,765	\$5,880	\$6,605	\$8,000	\$10,020	\$11,960	\$13,950
40PP	\$6,741	\$6,867	\$7,035	\$7,676	\$9,100	\$11,370	\$13,640	\$15,950
44PP	\$7,235	\$7,371	\$7,560	\$8,411	\$10,060	\$12,630	\$15,080	\$17,600
48PP	\$7,508	\$7,655	\$7,875	\$8,547	\$10,480	\$13,110	\$15,720	\$18,250
52PP	\$7,928	\$8,064	\$8,400	\$9,261	\$11,340	\$14,340	\$17,080	\$19,900
56PP	\$9,261	\$9,513	\$9,555	\$10,353	\$12,460	\$15,660	\$18,800	\$21,900
60PP	\$9,545	\$9,765	\$10,028	\$11,078	\$13,500	\$16,920	\$20,200	\$23,550
64PP	\$9,776	\$10,049	\$10,290	\$11,246	\$13,960	\$17,430	\$20,840	\$24,300
72PP	\$10,322	\$10,836	\$11,372	\$13,241	\$15,740	\$19,200	\$22,680	\$27,500
80PP	\$10,647	\$11,183	\$11,697	\$13,577	\$16,080	\$19,530	\$23,040	\$27,900
88PP	\$12,149	\$12,789	\$13,419	\$15,645	\$18,700	\$23,130	\$27,320	\$33,050
96PP	\$12,474	\$13,104	\$13,745	\$15,971	\$19,040	\$23,460	\$27,680	\$33,450
104PP	\$13,976	\$14,711	\$15,456	\$18,029	\$22,020	\$26,880	\$31,720	\$38,450
112PP	\$14,312	\$15,026	\$15,782	\$18,375	\$22,360	\$27,210	\$32,080	\$38,850
120PP	\$15,813	\$16,632	\$17,483	\$20,433	\$25,060	\$30,780	\$36,320	\$44,000
128PP	\$16,139	\$16,979	\$17,798	\$20,769	\$25,400	\$31,110	\$36,680	\$44,400
136PP	\$17,630	\$18,585	\$19,425	\$22,817	\$28,120	\$34,530	\$40,600	\$49,400
144PP	\$17,955	\$18,900	\$19,845	\$23,153	\$28,440	\$34,860	\$40,960	\$49,800

## Booklets Full Colour Perfect Binding Booklets

## 128g Gloss Art Paper



A5 Full Colour Inner (Upright Orientation)								
Qty. Page	100 pcs	300 pcs	500 pcs	1,000 pcs	2,000 pcs	3,000 pcs	4,000 pcs	5,000 pcs
32PP	\$2,930	\$3,024	\$3,140	\$3,780	\$4,140	\$5,100	\$6,360	\$7,400
36PP	\$3,276	\$3,402	\$3,570	\$4,137	\$4,800	\$6,090	\$7,280	\$8,500
40PP	\$3,539	\$3,686	\$3,791	\$4,494	\$5,140	\$6,570	\$7,800	\$9,100
44PP	\$3,896	\$4,032	\$4,095	\$4,935	\$5,900	\$7,470	\$8,840	\$10,300
48PP	\$4,788	\$4,946	\$5,093	\$5,492	\$6,360	\$8,070	\$9,680	\$11,350
52PP	\$5,093	\$5,229	\$5,387	\$6,038	\$7,080	\$8,970	\$10,800	\$12,550
56PP	\$5,334	\$5,481	\$5,639	\$6,290	\$7,420	\$9,420	\$11,320	\$13,150
60PP	\$5,639	\$5,796	\$5,933	\$6,489	\$8,080	\$10,260	\$12,240	\$14,300
64PP	\$5,639	\$5,796	\$5,933	\$6,489	\$8,080	\$10,260	\$12,240	\$14,300
72PP	\$6,867	\$7,119	\$7,350	\$8,127	\$9,120	\$10,440	\$13,360	\$16,000
80PP	\$7,067	\$7,340	\$7,613	\$8,505	\$9,580	\$11,100	\$14,280	\$17,200
88PP	\$8,106	\$8,379	\$8,684	\$9,650	\$10,860	\$12,540	\$16,320	\$19,550
96PP	\$8,831	\$9,135	\$9,461	\$10,584	\$11,080	\$13,830	\$16,800	\$20,200
104PP	\$9,072	\$9,419	\$9,765	\$10,899	\$12,500	\$14,280	\$18,840	\$22,600
112PP	\$9,272	\$9,639	\$10,017	\$11,277	\$12,960	\$14,940	\$19,760	\$23,800
120PP	\$10,311	\$10,710	\$11,078	\$12,432	\$14,420	\$16,380	\$21,800	\$26,150
128PP	\$11,298	\$11,718	\$12,128	\$13,640	\$15,280	\$18,000	\$22,240	\$26,800
136PP	\$12,327	\$12,789	\$13,230	\$14,795	\$16,560	\$19,440	\$24,280	\$29,150
144PP	\$12,537	\$13,010	\$13,493	\$15,173	\$17,020	\$20,100	\$25,200	\$30,350

- Cost of printing, zinc plate and binding charges are included in the list above which is computed with 128g Gloss Art Paper
- Perfect binding booklet cover is recommended to use thicker paper with lamination, please refer to page 10-11 for further details
- Below 3,000pcs, 18% off, 3,000 pcs or above, 25% off

**Lead Time:** 3-5 working days

(Except for items with finishing, start from the date when customers confirm the proof)

Note: Please be aware that all the prices are subject to change without prior notice, please visit our website for the latest updates  
If finishing items are needed, please refer to page 95-109 for further details

## 128g Gloss Art Paper

A4 Single Colour Inner (Upright Orientation)								
Qty. Page	100 pcs	300 pcs	500 pcs	1,000 pcs	2,000 pcs	3,000 pcs	4,000 pcs	5,000 pcs
32PP	\$1,940	\$2,160	\$2,380	\$2,940	\$4,060	\$5,310	\$6,800	\$8,300
36PP	\$2,460	\$2,700	\$2,960	\$3,590	\$4,600	\$6,060	\$7,760	\$9,400
40PP	\$2,480	\$2,760	\$3,030	\$3,730	\$5,240	\$6,810	\$8,760	\$10,500
44PP	\$2,650	\$2,940	\$3,250	\$4,020	\$5,700	\$7,590	\$9,720	\$11,900
48PP	\$2,660	\$3,000	\$3,320	\$4,160	\$5,860	\$7,830	\$10,040	\$12,300
52PP	\$3,180	\$3,540	\$3,900	\$4,810	\$6,760	\$8,940	\$11,360	\$13,800
56PP	\$3,200	\$3,570	\$3,970	\$4,950	\$7,140	\$9,360	\$12,000	\$14,500
60PP	\$3,370	\$3,780	\$4,190	\$5,240	\$7,600	\$10,110	\$12,960	\$15,850
64PP	\$3,380	\$3,810	\$4,260	\$5,380	\$7,760	\$10,350	\$13,280	\$16,250
72PP	\$4,920	\$5,400	\$5,910	\$7,170	\$9,780	\$12,600	\$16,200	\$19,650
80PP	\$5,100	\$5,640	\$6,200	\$7,600	\$10,400	\$13,620	\$17,480	\$21,400
88PP	\$5,640	\$6,240	\$6,850	\$8,390	\$11,560	\$15,270	\$19,600	\$23,850
96PP	\$5,820	\$6,480	\$7,140	\$8,820	\$12,180	\$16,290	\$20,920	\$25,600
104PP	\$6,360	\$7,080	\$7,790	\$9,610	\$13,500	\$17,940	\$23,040	\$28,000
112PP	\$6,540	\$7,320	\$8,080	\$10,040	\$14,120	\$18,960	\$24,320	\$29,800
120PP	\$7,080	\$7,890	\$8,730	\$10,830	\$15,480	\$20,610	\$26,440	\$32,200
128PP	\$7,260	\$8,130	\$9,020	\$11,260	\$16,120	\$21,600	\$27,760	\$33,950
136PP	\$7,800	\$8,730	\$9,670	\$12,050	\$17,480	\$23,250	\$29,880	\$36,400
144PP	\$7,980	\$8,970	\$9,960	\$12,480	\$18,100	\$24,270	\$31,160	\$38,150

## Booklets Single Colour Perfect Binding Booklets

## 128g Gloss Art Paper

A5 Single Colour Inner (Upright Orientation)								
Qty. Page	100 pcs	300 pcs	500 pcs	1,000 pcs	2,000 pcs	3,000 pcs	4,000 pcs	5,000 pcs
32PP	\$1,580	\$1,680	\$1,800	\$2,080	\$2,800	\$3,270	\$4,200	\$4,800
36PP	\$1,730	\$1,860	\$1,980	\$2,300	\$2,960	\$3,840	\$4,840	\$5,800
40PP	\$1,740	\$1,890	\$2,020	\$2,370	\$3,080	\$4,050	\$5,120	\$6,150
44PP	\$2,110	\$2,250	\$2,400	\$2,800	\$3,960	\$4,770	\$6,120	\$6,950
48PP	\$2,120	\$2,280	\$2,450	\$2,870	\$3,980	\$4,800	\$6,160	\$7,000
52PP	\$2,270	\$2,460	\$2,650	\$3,090	\$4,220	\$5,370	\$6,760	\$8,000
56PP	\$2,280	\$2,490	\$2,700	\$3,160	\$4,360	\$5,580	\$7,040	\$8,350
60PP	\$2,650	\$2,850	\$3,050	\$3,590	\$5,220	\$6,300	\$8,040	\$9,150
64PP	\$2,660	\$2,880	\$3,100	\$3,660	\$5,240	\$6,330	\$8,080	\$9,200
72PP	\$3,460	\$3,720	\$3,960	\$4,590	\$5,840	\$7,500	\$9,560	\$11,650
80PP	\$3,480	\$3,750	\$4,030	\$4,730	\$6,220	\$7,920	\$10,200	\$12,350
88PP	\$3,650	\$3,870	\$4,250	\$5,020	\$6,560	\$8,820	\$11,360	\$13,900
96PP	\$3,660	\$3,990	\$4,320	\$5,160	\$6,840	\$9,240	\$11,920	\$14,600
104PP	\$4,180	\$4,530	\$4,900	\$5,810	\$7,780	\$10,470	\$13,400	\$16,350
112PP	\$4,200	\$4,590	\$4,970	\$5,950	\$8,000	\$10,560	\$13,600	\$16,500
120PP	\$4,370	\$4,770	\$5,190	\$6,240	\$8,720	\$11,790	\$15,200	\$18,600
128PP	\$4,380	\$4,830	\$5,260	\$6,380	\$9,000	\$12,210	\$15,760	\$19,300
136PP	\$4,900	\$5,370	\$5,840	\$7,030	\$9,980	\$13,440	\$17,240	\$21,050
144PP	\$4,920	\$5,400	\$5,910	\$7,170	\$10,360	\$13,860	\$17,880	\$21,750

- Cost of printing, zinc plate and binding charges are included in the list above which is computed with 128g Gloss Art Paper
- Perfect binding booklet cover is recommended to use thicker paper with lamination, please refer to page 10-11 for further details

**Lead Time: 3-5 working days**  
(Except for items with finishing, start from the date when customers confirm the proof)

Note: Please be aware that all the prices are subject to change without prior notice, please visit our website for the latest updates  
If finishing items are needed, please refer to page 95-109 for further details

## 128g Gloss Art Paper



A4 Full Colour Inner (Upright Orientation)								
Qty. Page	100 pcs	300 pcs	500 pcs	1,000 pcs	2,000 pcs	3,000 pcs	4,000 pcs	5,000 pcs
32PP	\$5,472	\$5,739	\$6,006	\$6,678	\$7,640	\$9,000	\$10,840	\$12,650
40PP	\$6,555	\$6,858	\$7,156	\$7,917	\$8,980	\$10,740	\$13,160	\$15,850
48PP	\$7,419	\$7,821	\$8,227	\$9,230	\$10,700	\$12,750	\$15,640	\$18,800
56PP	\$8,503	\$8,940	\$9,377	\$10,469	\$12,040	\$14,640	\$18,360	\$22,100
64PP	\$9,368	\$9,904	\$10,442	\$11,781	\$13,780	\$16,650	\$20,880	\$25,100
72PP	\$10,451	\$11,022	\$11,592	\$13,440	\$16,000	\$20,100	\$23,600	\$28,350
80PP	\$11,316	\$11,986	\$12,658	\$14,333	\$16,840	\$20,790	\$26,080	\$31,350
88PP	\$12,399	\$13,104	\$13,808	\$16,170	\$18,320	\$22,980	\$28,800	\$34,650
96PP	\$13,265	\$14,068	\$14,873	\$16,884	\$20,060	\$24,960	\$31,280	\$37,650
104PP	\$14,347	\$15,186	\$16,023	\$18,123	\$21,680	\$27,120	\$34,000	\$40,900
112PP	\$15,212	\$16,150	\$17,089	\$19,436	\$23,400	\$29,130	\$36,520	\$43,900
120PP	\$16,296	\$17,268	\$18,239	\$20,675	\$25,200	\$31,290	\$39,240	\$47,200
128PP	\$17,160	\$18,232	\$19,304	\$21,987	\$26,740	\$33,270	\$41,720	\$50,150
136PP	\$18,244	\$19,350	\$20,454	\$23,226	\$28,360	\$35,460	\$44,440	\$53,450
144PP	\$19,109	\$20,314	\$21,525	\$24,539	\$30,100	\$37,440	\$46,960	\$56,450
152PP	\$20,193	\$21,433	\$22,675	\$25,778	\$31,700	\$39,600	\$49,680	\$59,750
160PP	\$21,057	\$22,397	\$23,741	\$27,090	\$33,440	\$41,610	\$52,160	\$62,700
168PP	\$22,140	\$23,515	\$24,890	\$28,340	\$35,040	\$43,770	\$54,880	\$66,000
176PP	\$23,006	\$24,479	\$25,956	\$29,652	\$36,780	\$45,750	\$57,360	\$69,000
184PP	\$24,088	\$25,597	\$27,106	\$31,038	\$38,619	\$48,038	\$60,228	\$72,450
192PP	\$24,953	\$26,564	\$28,172	\$32,351	\$40,164	\$49,959	\$62,637	\$75,348

## Booklets Full Colour Sewn Perfect Binding Booklets

## 128g Gloss Art Paper



A5 Full Colour Inner (Upright Orientation)								
Qty. Page	100 pcs	300 pcs	500 pcs	1,000 pcs	2,000 pcs	3,000 pcs	4,000 pcs	5,000 pcs
32PP	\$4,028	\$4,205	\$4,379	\$4,820	\$5,440	\$6,270	\$7,200	\$8,350
40PP	\$4,710	\$4,886	\$5,061	\$5,765	\$6,540	\$7,620	\$8,840	\$10,600
48PP	\$5,232	\$5,453	\$5,675	\$6,227	\$6,980	\$8,220	\$9,840	\$11,900
56PP	\$5,915	\$6,136	\$6,358	\$7,172	\$8,080	\$9,720	\$11,880	\$14,300
64PP	\$6,481	\$6,832	\$7,187	\$8,064	\$9,360	\$11,190	\$13,600	\$16,450
72PP	\$7,163	\$7,516	\$7,870	\$9,009	\$10,460	\$12,960	\$15,640	\$18,850
80PP	\$7,685	\$8,083	\$8,479	\$9,471	\$10,920	\$13,530	\$16,640	\$20,100
88PP	\$8,367	\$8,763	\$9,161	\$10,416	\$12,160	\$15,300	\$18,680	\$22,500
96PP	\$8,933	\$9,463	\$9,991	\$11,319	\$13,440	\$16,800	\$20,360	\$24,700
104PP	\$9,616	\$10,146	\$10,673	\$12,264	\$14,820	\$18,570	\$22,440	\$27,050
112PP	\$10,138	\$10,710	\$11,288	\$12,716	\$15,260	\$19,140	\$23,400	\$28,350
120PP	\$10,820	\$11,394	\$11,970	\$13,661	\$16,640	\$20,910	\$25,480	\$30,750
128PP	\$11,386	\$12,093	\$12,800	\$14,564	\$17,920	\$22,380	\$27,160	\$32,900
136PP	\$12,069	\$12,978	\$13,482	\$15,509	\$19,300	\$24,150	\$29,240	\$35,300
144PP	\$12,591	\$13,340	\$14,091	\$15,971	\$19,760	\$24,750	\$30,200	\$36,600
152PP	\$13,273	\$14,024	\$14,774	\$16,916	\$21,120	\$26,490	\$32,240	\$38,950
160PP	\$13,839	\$14,723	\$15,603	\$17,808	\$22,420	\$27,990	\$33,960	\$41,150
168PP	\$14,522	\$15,404	\$16,286	\$18,764	\$23,780	\$29,760	\$36,000	\$43,550
176PP	\$15,043	\$15,971	\$16,895	\$19,226	\$24,240	\$30,330	\$37,000	\$44,800
184PP	\$15,726	\$16,654	\$17,577	\$20,318	\$25,600	\$32,100	\$39,040	\$47,200
192PP	\$16,293	\$17,350	\$18,412	\$21,210	\$26,900	\$33,600	\$40,760	\$49,350

- Cost of printing, zinc plate and binding charges are included in the list above which is computed with 128g Gloss Art Paper
- Sewn perfect binding booklet cover is recommended to use thicker paper with lamination, please refer to page 10-11 for further details
- Below 3,000pcs, 18% off, 3,000 pcs or above, 25% off

**Lead Time: 6-7 working days**  
(Except for items with finishing, start from the date when customers confirm the proof)

Note: Please be aware that all the prices are subject to change without prior notice, please visit our website for the latest updates  
If finishing items are needed, please refer to page 95-109 for further details

## 128g Gloss Art Paper

A4 Single Colour Inner (Upright Orientation)								
Qty. Page	100 pcs	300 pcs	500 pcs	1,000 pcs	2,000 pcs	3,000 pcs	4,000 pcs	5,000 pcs
32PP	\$3,111	\$3,366	\$3,620	\$4,260	\$5,540	\$6,900	\$8,440	\$9,950
40PP	\$3,523	\$3,810	\$4,095	\$4,820	\$6,260	\$7,800	\$9,720	\$11,950
48PP	\$3,916	\$4,299	\$4,685	\$5,640	\$7,560	\$9,600	\$12,040	\$14,750
56PP	\$4,328	\$4,743	\$5,160	\$6,200	\$8,280	\$10,650	\$13,760	\$16,850
64PP	\$4,722	\$5,232	\$5,745	\$7,020	\$9,580	\$12,450	\$16,080	\$19,700
72PP	\$5,133	\$5,676	\$6,220	\$7,580	\$10,280	\$13,770	\$18,400	\$21,750
80PP	\$5,527	\$6,165	\$6,805	\$8,400	\$11,600	\$15,540	\$20,080	\$24,600
88PP	\$5,939	\$6,609	\$7,280	\$8,960	\$12,460	\$16,890	\$21,800	\$26,700
96PP	\$6,333	\$7,098	\$7,865	\$9,780	\$13,760	\$18,660	\$24,080	\$29,550
104PP	\$6,744	\$7,542	\$8,340	\$10,340	\$14,760	\$19,980	\$25,800	\$31,600
112PP	\$7,138	\$8,031	\$8,925	\$11,160	\$16,060	\$21,780	\$28,120	\$34,450
120PP	\$7,550	\$8,475	\$9,400	\$11,720	\$17,040	\$23,100	\$29,800	\$36,550
128PP	\$7,943	\$8,964	\$9,985	\$12,540	\$18,340	\$24,870	\$32,120	\$39,350
136PP	\$8,355	\$9,408	\$10,460	\$13,100	\$19,340	\$26,220	\$33,840	\$41,450
144PP	\$8,749	\$9,897	\$11,050	\$13,920	\$20,640	\$27,990	\$36,160	\$44,300
152PP	\$9,161	\$10,341	\$11,525	\$14,480	\$21,640	\$29,310	\$37,840	\$46,400
160PP	\$9,554	\$10,830	\$12,110	\$15,300	\$22,940	\$31,110	\$40,160	\$49,200
168PP	\$9,966	\$11,274	\$12,585	\$15,870	\$23,920	\$32,430	\$41,880	\$51,300
176PP	\$10,360	\$11,763	\$13,170	\$16,690	\$25,240	\$34,200	\$44,160	\$54,150
184PP	\$10,771	\$12,207	\$13,645	\$17,390	\$26,220	\$35,520	\$45,880	\$56,200
192PP	\$11,165	\$12,699	\$14,230	\$18,210	\$27,520	\$37,320	\$48,200	\$59,050

## Booklets Single Colour Sewn Perfect Binding Booklets

## 128g Gloss Art Paper

A5 Single Colour Inner (Upright Orientation)								
Qty. Page	100 pcs	300 pcs	500 pcs	1,000 pcs	2,000 pcs	3,000 pcs	4,000 pcs	5,000 pcs
32PP	\$2,305	\$2,433	\$2,560	\$2,880	\$3,520	\$4,200	\$4,960	\$5,750
40PP	\$2,609	\$2,754	\$2,895	\$3,260	\$3,980	\$4,770	\$5,840	\$7,150
48PP	\$2,717	\$2,877	\$3,035	\$3,440	\$4,240	\$5,100	\$6,280	\$7,700
56PP	\$3,021	\$3,198	\$3,370	\$3,810	\$4,680	\$5,850	\$7,520	\$9,200
64PP	\$3,111	\$3,366	\$3,620	\$4,260	\$5,540	\$7,050	\$9,120	\$11,200
72PP	\$3,470	\$3,810	\$4,000	\$4,700	\$5,940	\$8,040	\$10,400	\$12,750
80PP	\$3,523	\$3,810	\$4,095	\$4,820	\$6,120	\$8,370	\$10,840	\$13,300
88PP	\$3,826	\$4,131	\$4,435	\$5,190	\$6,860	\$9,360	\$12,120	\$14,850
96PP	\$3,916	\$4,299	\$4,685	\$5,640	\$7,700	\$10,560	\$13,680	\$16,850
104PP	\$4,220	\$4,620	\$5,020	\$6,020	\$8,440	\$11,550	\$14,960	\$18,350
112PP	\$4,328	\$4,743	\$5,160	\$6,200	\$8,700	\$11,880	\$15,400	\$18,900
120PP	\$4,632	\$5,064	\$5,495	\$6,570	\$9,420	\$12,900	\$16,680	\$20,450
128PP	\$4,722	\$5,232	\$5,745	\$7,020	\$10,280	\$14,100	\$18,280	\$22,450
136PP	\$5,025	\$5,553	\$6,080	\$7,400	\$11,000	\$15,090	\$19,520	\$23,950
144PP	\$5,133	\$5,676	\$6,220	\$7,580	\$11,260	\$15,420	\$19,960	\$24,500
152PP	\$5,437	\$5,997	\$6,555	\$7,950	\$12,000	\$16,410	\$21,240	\$26,050
160PP	\$5,527	\$6,165	\$6,805	\$8,400	\$12,840	\$17,610	\$22,840	\$28,050
168PP	\$5,831	\$6,486	\$7,140	\$8,790	\$13,580	\$18,600	\$24,080	\$29,600
176PP	\$5,939	\$6,609	\$7,280	\$8,970	\$13,840	\$18,930	\$24,520	\$30,150
184PP	\$6,243	\$6,930	\$7,615	\$9,480	\$14,560	\$19,950	\$25,800	\$31,650
192PP	\$6,333	\$7,098	\$7,865	\$9,930	\$15,420	\$21,120	\$27,400	\$33,650

- Cost of printing, zinc plate and binding charges are included in the list above which is computed with 128g Gloss Art Paper
- Sewn perfect binding booklet cover is recommended to use thicker paper with lamination, please refer to page 10-11 for further details

**Lead Time: 6-7 working days**

(Except for items with finishing, start from the date when customers confirm the proof)

Note: Please be aware that all the prices are subject to change without prior notice, please visit our website for the latest updates  
If finishing items are needed, please refer to page 95-109 for further details

## Notebooks

A4					
Qty.	Type	Full Color Cover		Full Color Cover + UV	
		Single Color Inner	Full Color Inner	Single Color Inner	Full Color Inner
200 pcs		\$3,950	\$4,385	\$4,215	\$4,745
300 pcs		\$4,615	\$5,740	\$4,860	\$5,985
500 pcs		\$6,690	\$8,085	\$7,095	\$8,490
1,000 pcs		\$12,055	\$14,130	\$12,860	\$14,935
2,000 pcs		\$21,020	\$24,225	\$22,520	\$25,725
3,000 pcs		\$30,785	\$35,265	\$33,040	\$37,520
4,000 pcs		\$40,555	\$46,300	\$43,560	\$49,305
5,000 pcs		\$50,532	\$57,340	\$54,080	\$61,095

A5					
Qty.	Type	Full Color Cover		Full Color Cover + UV	
		Single Color Inner	Full Color Inner	Single Color Inner	Full Color Inner
200 pcs		—	—	—	—
300 pcs		\$3,465	\$4,455	\$4,875	\$4,780
500 pcs		\$4,815	\$5,940	\$6,310	\$6,145
1,000 pcs		\$8,160	\$9,560	\$9,855	\$9,965
2,000 pcs		\$13,775	\$15,715	\$14,525	\$16,465
3,000 pcs		\$20,180	\$22,750	\$21,310	\$23,880
4,000 pcs		\$26,340	\$29,545	\$27,840	\$31,045
5,000 pcs		\$32,740	\$36,580	\$34,620	\$38,460

A6					
Qty.	Type	Full Color Cover		Full Color Cover + UV	
		Single Color Inner	Full Color Inner	Single Color Inner	Full Color Inner
200 pcs		—	—	—	—
300 pcs		—	—	—	—
500 pcs		\$3,845	\$4,835	\$4,150	\$5,140
1,000 pcs		\$6,220	\$7,340	\$6,425	\$7,545
2,000 pcs		\$10,150	\$11,450	\$10,530	\$11,830
3,000 pcs		\$14,635	\$16,315	\$15,200	\$16,880
4,000 pcs		\$18,980	\$20,915	\$19,730	\$21,665
5,000 pcs		\$23,985	\$26,555	\$24,930	\$27,500

- The cover of the Notebook could be in double-sided printed in full colour or black & white
- The cover of Notebook must use 310g Gloss double-sided coated cardboard, double-sided color printing and single-sided Matt Cover
- The inside pages of Notebook must use 80 Sheets (160pp), 80g paper, unified design for inside pages
- The inside pages of Notebook can be used standard template or design file
- The spine of Notebook must be in 14mm
- The double wire-o of Notebook used are black in colour
- Notebook can ONLY be applied to the standard sizes as mentioned above; all standard Notebook die-cutters can be downloaded at "Download" in the company website [www.e-print.com.hk](http://www.e-print.com.hk) (Not available for other sizes)
- Finishing items could be applied to Notebook, additional charges for finishing items
- Please visit our branches for more product information

**Lead Time: 7-10 working days**

\* Collecting from branches + 1 working day

(Except for items with finishing, start from the date when customers confirm the proof)

Note: Please be aware that all the prices are subject to change without prior notice, please visit our website for the latest updates  
If finishing items are needed, please refer to page 95-109 for further details

## Paper Placemats

70 / 80g Woodfree Paper

	260 x 368mm 70g	A3 297 x 420mm 80g
Colour	4C + 0	4C + 0
Qty.	Price	
5,000 pcs	\$1,200	\$1,400
10,000 pcs	\$1,500	\$2,000
20,000 pcs	\$2,350	\$3,220
30,000 pcs	\$3,400	\$4,620
40,000 pcs	\$4,250	\$5,860
50,000 pcs	\$5,300	\$7,260
100,000 pcs	\$10,000	\$13,770

**Lead Time:** 1 working day  
(Except for items with finishing, start from the date when customers confirm the proof)

Note: Please be aware that all the prices are subject to change without prior notice, please visit our website for the latest updates  
If finishing items are needed, please refer to page 95-109 for further details

## Calendars Desk Calendars

*Extended Size on Last Sheet, Expand Your Ideas!*

260g White Woodfree Paper with Glob Pattern

	Model A 170 (H) x 148 (W) mm	Model B 112 (H) x 170 (W) mm
Qty.	Price	
100 pcs	\$1,742	\$1,396
200 pcs	\$2,916	\$2,430
300 pcs	\$4,089	\$3,465
400 pcs	\$5,266	\$4,351
500 pcs	\$6,152	\$5,173
1,000 pcs	\$10,581	\$9,283
1,500 pcs	\$15,011	\$13,394
2,000 pcs	\$19,440	\$17,505

- The cover and inside pages of Desk Calendar are double-sided printed in full colour
- The stand and wire-o of Desk Calendar used are grey and black in colour respectively
- Desk Calendar can ONLY be applied to the standard sizes as mentioned above; all standard Desk Calendar die-cutters can be downloaded at "Download" in the company website [www.e-print.com.hk](http://www.e-print.com.hk)
- **Applicable finishing item:** Foil Stamping can be applied to the paper of Desk Calendar only (Please refer to the Price List of Foil Stamping)  
(No effects of gradients, overprint and knockout in the finishing design)
- For any quantity or price which are not listed above, please refer to the company website
- Please visit our branches for more product information

**Lead Time:** 7-9 working days  
\* Collecting from branches + 1 working day  
(Please refer to the lead time of Foil Stamping)

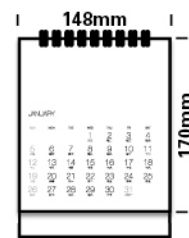

**Model A**

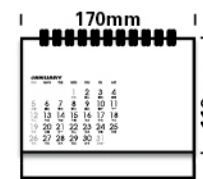

**Model B**

Note: Please be aware that all the prices are subject to change without prior notice, please visit our website for the latest updates  
If finishing items are needed, please refer to page 95-109 for further details

## Calendars

# Wall Calendar and Mini Wall Calendar <sup>New</sup>

Qty.	Mini Wall Calendar 90 (H) x 90 (W) mm		Wall Calendar Model A 294 (H) x 387 (W) mm		Wall Calendar Model B 210 (H) x 297 (W) mm	
	157g Matt Art Paper	140g Woodfree Paper	157g Matt Art Paper	140g Woodfree Paper	157g Matt Art Paper	140g Woodfree Paper
100 pcs	\$1,135	\$1,140	\$3,570	\$3,665	\$2,695	\$2,755
200 pcs	\$1,385	\$1,395	\$4,125	\$4,255	\$3,120	\$3,195
300 pcs	\$1,635	\$1,650	\$4,675	\$4,845	\$3,540	\$3,630
500 pcs	\$2,140	\$2,160	\$5,780	\$6,020	\$4,390	\$4,510
800 pcs	\$2,890	\$2,920	\$7,440	\$7,780	\$5,640	\$5,825
1,000 pcs	\$3,395	\$3,425	\$8,545	\$8,960	\$6,785	\$6,700
1,500 pcs	\$4,680	\$4,730	\$11,375	\$11,965	\$8,585	\$8,890
2,000 pcs	\$5,970	\$6,030	\$14,205	\$14,965	\$10,690	\$11,080
2,500 pcs	\$7,255	\$7,335	\$17,210	\$18,150	\$12,885	\$13,365
3,000 pcs	\$8,610	\$8,700	\$20,400	\$21,450	\$15,210	\$15,810

- The cover and back cover of wall calendar are using 300g Double-sided Coated Art Paper
- The cover of wall calendar are double-sided printing
- The back cover of wall calendar must be defaulted red in color
- The inside pages of wall calendar can choose from 157g Matt Art Paper or 140g Woodfree Paper with single-sided printing
- The double wire-o of wall calendars used are white in color
- The wall calendar will be packed individually with plastic bag and red ribbon; the standard length of the red ribbon is 18-32cm (cost already included in the above price)
- For any quantity which do not list above, please seek for quotation
- Wall calendar can ONLY be applied to the standard sizes as mentioned above; all standard die-cutters can be downloaded at "Download" in the company website [www.e-print.com.hk](http://www.e-print.com.hk)
- Finishing items could be applied to wall calendars, such as Double-Sided Matt Lamination, Foil Stamping, Spot UV, and Embossing, additional charges for finishing items (finishing items only applicable to the cover of wall calendar)
- Please pay attention to the image and frame design when choosing finishing items. Gradient, overprint and knockout are not recommended as the difficulty to rectify position during operation process
- Please visit our branches for more product information

### Lead Time: 9 working days

- \* Collecting from branches + 1 working day  
(Except for items with finishing, start from the date when customers confirm the proof)

Note: Please be aware that all the prices are subject to change without prior notice, please visit our website for the latest updates  
If finishing items are needed, please refer to page 95-109 for further details

## Calendars

# Vertical Wall Calendar <sup>New</sup>

Qty.	Type	Vertical Wall Calendar Model A 387 (H) x 294 (W) mm		Vertical Wall Calendar Model B 297 (H) x 210 (W) mm	
		157g Matt Art Paper	140g Woodfree Paper	157g Matt Art Paper	140g Woodfree Paper
100 pcs		\$3,220	\$3,300	\$2,400	\$2,445
200 pcs		\$3,695	\$3,805	\$2,765	\$2,830
300 pcs		\$4,165	\$4,310	\$3,135	\$3,245
500 pcs		\$5,110	\$5,320	\$3,870	\$3,980
800 pcs		\$6,530	\$6,835	\$4,970	\$5,130
1,000 pcs		\$7,475	\$7,845	\$5,705	\$5,900
1,500 pcs		\$9,870	\$10,400	\$7,545	\$7,815
2,000 pcs		\$12,265	\$12,960	\$9,380	\$9,735
2,500 pcs		\$14,880	\$15,735	\$11,410	\$11,840
3,000 pcs		\$17,650	\$18,650	\$13,500	\$14,100

- The cover and back cover of vertical wall calendar are using 300g Double-sided Coated Art Paper
- The cover of vertical wall calendar are single-sided printing
- The inside pages of vertical wall calendar can choose from 157g Matt Art Paper or 140g Woodfree Paper with single-sided printing
- The double wire-o of wall calendars used are white in color
- The vertical wall calendar will be packed individually with plastic bag (cost already included in the above price)
- For any quantity which do not list above, please seek for quotation
- Wall calendar can ONLY be applied to the standard sizes as mentioned above; all standard die-cutters can be downloaded at "Download" in the company website [www.e-print.com.hk](http://www.e-print.com.hk)
- Finishing items could be applied to wall calendars, such as Single-Sided Matt Lamination, Foil Stamping, Spot UV, and Embossing, additional charges for finishing items (finishing items only applicable to the cover of wall calendar)
- Please pay attention to the image and frame design when choosing finishing items. Gradient, overprint and knockout are not recommended as the difficulty to rectify position during operation process
- Please visit our branches for more product information

### Lead Time: 9 working days

- \* Collecting from branches + 1 working day  
(Except for items with finishing, start from the date when customers confirm the proof)

Note: Please be aware that all the prices are subject to change without prior notice, please visit our website for the latest updates  
If finishing items are needed, please refer to page 95-109 for further details



# Saddle Stitching Wall Calendar <sup>New</sup>

		Saddle Stitching Wall Calendar 145 (H) x 145 (W) mm	
		128g Gloss Art Paper	
Qty.	Type		
100 pcs		\$2,440	
200 pcs		\$2,600	
300 pcs		\$2,765	
500 pcs		\$3,090	
800 pcs		\$3,575	
1,000 pcs		\$3,900	
1,500 pcs		\$4,710	
2,000 pcs		\$5,520	
2,500 pcs		\$6,450	
3,000 pcs		\$7,530	

- The cover and back cover of saddle stitching wall calendar are using 210g Gloss Art Paper with double-sided printing
- The cover and back cover of saddle stitching wall calendar are using Single-sided Gloss lamination
- The inside pages of saddle stitching wall calendar use from 128g Gloss Art Paper with double-sided printing
- The saddle stitching wall calendar will be packed individually with plastic bag (cost already included in the above price)
- For any quantity which do not list above, please seek for quotation
- Saddle stitching wall calendar can ONLY be applied to the standard sizes as mentioned above; all standard die-cutters can be downloaded at "Download" in the company website [www.e-print.com.hk](http://www.e-print.com.hk)
- Finishing items could be applied to wall calendars, such as Foil Stamping, and Embossing, additional charges for finishing items (finishing items only applicable to the cover and the display image sheet of saddle stitching wall calendar)
- Please pay attention to the image and frame design when choosing finishing items. Gradient, overprint and knockout are not recommended as the difficulty to rectify position during operation process
- Please visit our branches for more product information

**Lead Time:** 6 working days

\* Collecting from branches + 1 working day

(Except for items with finishing, start from the date when customers confirm the proof)

Note: Please be aware that all the prices are subject to change without prior notice, please visit our website for the latest updates  
If finishing items are needed, please refer to page 95-109 for further details

### Artwork Diagram

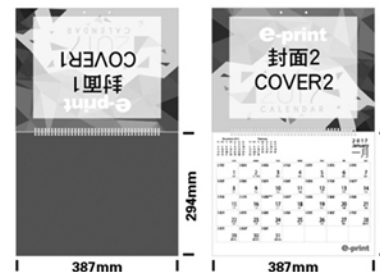

**Model A Wall Calendar**  
294 (H) x 387 (W) mm

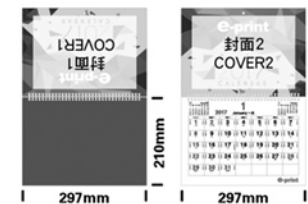

**Model B Wall Calendar**  
210 (H) x 297 (W) mm

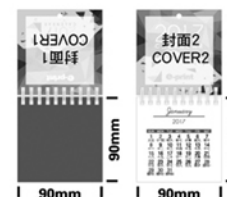

**Mini Wall Calendar**  
90 (H) x 90 (W) mm

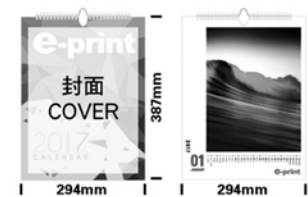

**Model A Vertical Wall Calendar**  
387 (H) x 294 (W) mm

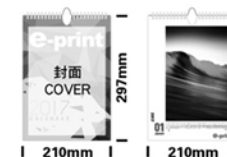

**Model B Vertical Wall Calendar**  
297 (H) x 210 (W) mm



**Saddle Stitching Wall Calendar**  
145 (H) x 145 (W) mm

## 140g Woodfree Paper

4C + 0			
Qty. \ Size	3.5 (W) x 3.5 (H) "	3.5 (W) x 4.75 (H) "	3.5 (W) x 6.75 (H) " & 6.65 (W) x 3.35 (H) "
100 pcs	\$400	\$417	\$435
200 pcs	\$500	\$521	\$566
300 pcs	\$550	\$584	\$630
500 pcs	\$646	\$663	\$681
1,000 pcs	\$770	\$791	\$836
2,000 pcs	\$1,174	\$1,208	\$1,323
3,000 pcs	\$1,460	\$1,503	\$1,746
5,000 pcs	\$2,065	\$2,126	\$2,593
6,000 pcs	\$2,384	\$2,455	\$2,971
8,000 pcs	\$3,022	\$3,112	\$3,690
10,000 pcs	\$3,660	\$3,769	\$4,409

## 157g Matt Art Paper

4C + 0			
Qty. \ Size	3.5 (W) x 3.5 (H) "	3.5 (W) x 4.75 (H) "	3.5 (W) x 6.75 (H) " & 6.65 (W) x 3.35 (H) "
100 pcs	\$400	\$417	\$439
200 pcs	\$500	\$522	\$574
300 pcs	\$550	\$588	\$640
500 pcs	\$734	\$751	\$773
1,000 pcs	\$867	\$889	\$941
2,000 pcs	\$1,305	\$1,343	\$1,473
3,000 pcs	\$1,611	\$1,660	\$1,926
5,000 pcs	\$2,254	\$2,326	\$2,831
6,000 pcs	\$2,593	\$2,677	\$3,238
8,000 pcs	\$3,270	\$3,378	\$4,015
10,000 pcs	\$3,947	\$4,078	\$4,792

## Red Packet

### 120g Icy White / Light Yellow / Titanium White Pearl Paper

4C + 0			
Qty. \ Size	3.5 (W) x 3.5 (H) "	3.5 (W) x 4.75 (H) "	3.5 (W) x 6.75 (H) " & 6.65 (W) x 3.35 (H) "
100 pcs	\$422	\$446	\$483
200 pcs	\$530	\$561	\$633
300 pcs	\$583	\$633	\$785
500 pcs	\$744	\$811	\$834
1,000 pcs	\$1,122	\$1,221	\$1,319
2,000 pcs	\$1,608	\$1,745	\$1,988
3,000 pcs	\$2,095	\$2,269	\$2,713
5,000 pcs	\$3,096	\$3,346	\$4,162
6,000 pcs	\$3,613	\$3,902	\$4,851
8,000 pcs	\$4,648	\$5,014	\$6,197
10,000 pcs	\$5,683	\$6,125	\$7,543

- Red Packets are printing in single-sided full colour 4C + 0
- Red Packets are only applicable for the paper and standard sizes mentioned above. All artwork templates can be downloaded at "Download" in the company website [www.e-print.com.hk](http://www.e-print.com.hk) (Custom sizes are not accepted)
- Red Packets are packaging with plastic bag for every 20 pieces
- **Applicable finishing items:** Foil Stamping ; Embossing (Please refer to the price of finishing items) (No effects of gradients, overprint and knockout in the finishing design)

**Lead Time:** 6 working days

\* Collecting from branches + 1 working day

(Except for items with finishing, start from the date when customers confirm the proof)

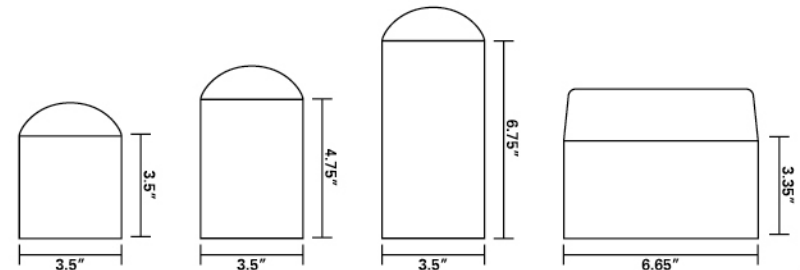

Note: Please be aware that all the prices are subject to change without prior notice, please visit our website for the latest updates

If finishing items are needed, please refer to page 95-109 for further details

## Rectangular Fai Chun – 157g Gloss Art Paper

105 x 297mm		
Qty.	Colour 4C + 0 / 4C + 4C	
	Limited Time Offer	Original Price
600 pcs	\$276	<del>\$290</del>
1,000 pcs	\$323	<del>\$340</del>
2,000 pcs	\$371	<del>\$390</del>
4,000 pcs	\$561	<del>\$590</del>
6,000 pcs	\$703	<del>\$740</del>
8,000 pcs	\$798	<del>\$840</del>
10,000 pcs	\$893	<del>\$940</del>
12,000 pcs	\$988	<del>\$1,040</del>
14,000 pcs	\$1,083	<del>\$1,140</del>
16,000 pcs	\$1,178	<del>\$1,240</del>
18,000 pcs	\$1,273	<del>\$1,340</del>
20,000 pcs	\$1,368	<del>\$1,440</del>

## Fai Chun <sup>New</sup>

## Diamond Shape Fai Chun – 157g Gloss Art Paper

260 x 260mm					
Qty.	Colour	4C + 0		4C + 4C	
		Limited Time Offer	Original Price	Limited Time Offer	Original Price
600 pcs		\$437	<del>\$460</del>	\$532	<del>\$560</del>
1,000 pcs		\$485	<del>\$510</del>	\$580	<del>\$610</del>
2,000 pcs		\$580	<del>\$610</del>	\$675	<del>\$710</del>
4,000 pcs		\$836	<del>\$880</del>	\$931	<del>\$980</del>
6,000 pcs		\$1,045	<del>\$1,100</del>	\$1,140	<del>\$1,200</del>
8,000 pcs		\$1,302	<del>\$1,370</del>	\$1,397	<del>\$1,470</del>
10,000 pcs		\$1,463	<del>\$1,540</del>	\$1,558	<del>\$1,640</del>
12,000 pcs		\$1,672	<del>\$1,760</del>	\$1,767	<del>\$1,860</del>
14,000 pcs		\$1,881	<del>\$1,980</del>	\$1,976	<del>\$2,080</del>
16,000 pcs		\$2,090	<del>\$2,200</del>	\$2,185	<del>\$2,300</del>
18,000 pcs		\$2,299	<del>\$2,420</del>	\$2,394	<del>\$2,520</del>
20,000 pcs		\$2,413	<del>\$2,540</del>	\$2,508	<del>\$2,640</del>

- Limited Time Offer is only applicable for the above shape of Fai Chun
- Original price will be restored after promotion period
- Suggest customers to use our product "Leaflet" for quotation and ordering when you require other sizes and papers
- Suggest customers to use our product "Leaflet" for quotation and ordering when it requires finishing items

Lead Time: 1 working day

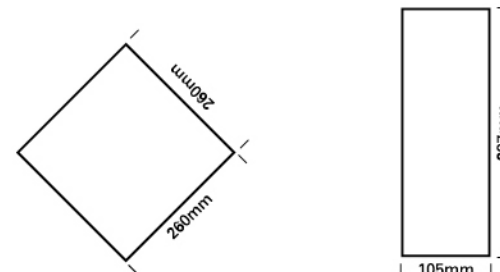

Note: Please be aware that all the prices are subject to change without prior notice, please visit our website for the latest updates

## Wedding Cards Package

Size	152 x 152mm (With Envelopes)			
Qty. \ Type	250g Matt Laminated Card	250g White Woodfree Card	250g Snow Pearl Card	250g Matt Laminated Card + Spot UV
100 pcs	\$195	\$265	\$1,160	\$795
200 pcs	\$285	\$390	\$1,290	\$865
300 pcs	\$375	\$515	\$1,460	\$1,020
400 pcs	\$465	\$645	\$1,595	\$1,190
500 pcs	\$555	\$770	\$1,730	\$1,295
1,000 pcs	\$1,005	\$1,410	\$2,390	\$1,820

Size	304 x 152mm (With ONE Creasing & Envelopes)			
Qty. \ Type	250g Matt Laminated Card	250g White Woodfree Card	250g Snow Pearl Card	250g Matt Laminated Card + Spot UV
100 pcs	\$485	\$560	\$1,430	\$1,075
200 pcs	\$605	\$695	\$1,635	\$1,230
300 pcs	\$730	\$835	\$1,845	\$1,385
400 pcs	\$855	\$970	\$2,060	\$1,540
500 pcs	\$980	\$1,105	\$2,270	\$1,695
1,000 pcs	\$1,595	\$1,790	\$3,320	\$2,470

Size	456 x 152mm (With TWO Creasing & Envelopes)			
Qty. \ Type	250g Matt Laminated Card	250g White Woodfree Card	250g Snow Pearl Card	250g Matt Laminated Card + Spot UV
100 pcs	\$635	\$750	\$1,520	\$1,150
200 pcs	\$795	\$930	\$1,810	\$1,350
300 pcs	\$950	\$1,105	\$2,095	\$1,560
400 pcs	\$1,105	\$1,280	\$2,380	\$1,760
500 pcs	\$1,265	\$1,455	\$2,670	\$1,970
1,000 pcs	\$2,050	\$2,340	\$4,105	\$2,990

## Wedding Cards <sup>New</sup>

### Wedding Cards (Cards Only)

Size	152 x 152mm (Cards Only)			
Qty. \ Type	250g Matt Laminated Card	250g White Woodfree Card	250g Snow Pearl Card	250g Matt Laminated Card + Spot UV
100 pcs	\$140	\$180	\$1,145	\$820
200 pcs	\$175	\$220	\$1,225	\$870
300 pcs	\$210	\$260	\$1,300	\$920
400 pcs	\$245	\$305	\$1,380	\$970
500 pcs	\$285	\$345	\$1,460	\$1,020
1,000 pcs	\$465	\$560	\$1,850	\$1,275

Size	304 x 152mm (Cards Only with ONE Creasing)			
Qty. \ Type	250g Matt Laminated Card	250g White Woodfree Card	250g Snow Pearl Card	250g Matt Laminated Card + Spot UV
100 pcs	\$430	\$505	\$1,375	\$1,020
200 pcs	\$500	\$590	\$1,530	\$1,120
300 pcs	\$565	\$670	\$1,685	\$1,220
400 pcs	\$635	\$750	\$1,840	\$1,325
500 pcs	\$705	\$835	\$1,995	\$1,425
1,000 pcs	\$1,050	\$1,245	\$2,775	\$1,925

Size	456 x 152mm (Cards Only with TWO Creasing)			
Qty. \ Type	250g Matt Laminated Card	250g White Woodfree Card	250g Snow Pearl Card	250g Matt Laminated Card + Spot UV
100 pcs	\$580	\$700	\$1,465	\$1,090
200 pcs	\$685	\$820	\$1,700	\$1,240
300 pcs	\$785	\$940	\$1,930	\$1,390
400 pcs	\$890	\$1,065	\$2,165	\$1,540
500 pcs	\$990	\$1,185	\$2,400	\$1,690
1,000 pcs	\$1,505	\$1,795	\$3,565	\$2,440

Note: Please be aware that all the prices are subject to change without prior notice, please visit our website for the latest updates  
If finishing items are needed, please refer to page 95-109 for further details

## Wedding Cards

### Artwork Diagram

- Wedding cards are using double-sided offset color printing
- Wedding cards can ONLY be applied to the standard materials such as 250g Matt Laminated Card, 260g White Woodfree Card, 250g Snow Pearl Card and 250g Matt Laminated Card + Spot UV (only applied to single-sided spot UV)
- Wedding cards can ONLY be applied to the standard sizes such as 152 x 152mm, 304 x 152mm or 456 x 152mm
- The wedding cards of 304 x 152mm already included ONE creasing; 456 x 152mm already included TWO creasing
- Wedding cards are only available in C.M.Y.K., Pantone colors will not be accepted
- The size of envelopes is 160 x 160mm (wallet style without window), 120g Pearl Paper. We provide 3 different colors (golden-yellow, red & silver), and printing cannot be applied on envelopes and no additional purchase
- Envelopes will be included in the wedding card package, 100pcs of envelopes will be included when you order 100pcs of wedding cards; 300pcs of envelopes will be included when order 300pcs of wedding cards
- Finishing items could be applied, such as Perforation, Creasing, Foil Stamping, Round Cornering, Embossing, Lamination, Die-cut (Additional charges for die-cutters) or Spot UV (Spot UV cannot be applied to White Woodfree Card); additional charges for finishing items
- The printed color will be affected on the paper nature with deep color or grain. Portrait and image printing are not recommend on these kind of papers
- The pictures on website are for reference only, please refer to the color and effect on the paper sample
- Different cards will present different effect and color based on the texture or grain of the paper, we suggest the fonts size not less than 5pt. and the lines not thinner than 0.3pt
- Please pay attention to the image and frame design when choosing finishing items. Gradient, overprint and knockout are not recommend as they are difficulty to rectify position during operation process
- Wedding cards can ONLY be applied to the standard sizes as mentioned above; all standard die-cutters can be downloaded at "Download" in the company website [www.e-print.com.hk](http://www.e-print.com.hk)
- Please visit our branches for more product information

### Lead Time: 2 working days

\* Collecting from branches + 1 working day

(Except for items with finishing, start from the date when customers confirm the proof)

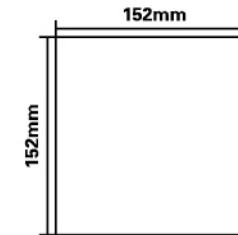

152 x 152mm (Cards Only)

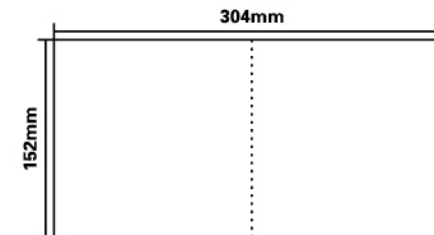

304 x 152mm (Cards Only with ONE Creasing)

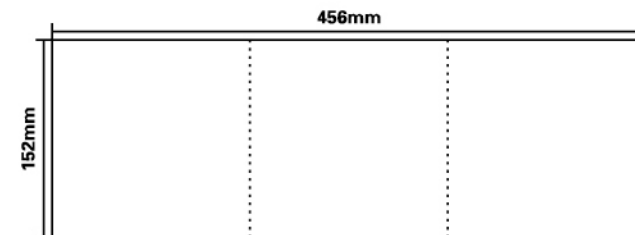

456 x 152mm (Cards Only with TWO Creasing)

Note: Please be aware that all the prices are subject to change without prior notice, please visit our website for the latest updates  
If finishing items are needed, please refer to page 95-109 for further details

## Envelopes – 100g Woodfree Paper

Type Qty.	4 x 9" & DL 110 x 220mm		C5 229 x 162mm	4.5 x 9.5"	
	Without Window	With Window	Without Window	Without Window	With Window
<b>500 pcs</b>	\$490	\$540	\$850	\$600	\$650
<b>1,000 pcs</b>	\$600	\$650	\$1,080	\$800	\$850
<b>2,000 pcs</b>	\$700	\$800	\$1,450	\$1,100	\$1,200
<b>3,000 pcs</b>	\$1,000	\$1,150	\$1,800	\$1,300	\$1,450
<b>4,000 pcs</b>	\$1,300	\$1,500	\$2,090	\$1,600	\$1,800
<b>5,000 pcs</b>	\$1,550	\$1,800	\$2,330	\$1,800	\$2,050
<b>10,000 pcs</b>	\$2,300	\$2,800	\$3,450	\$2,850	\$3,350

- Please seek for quotation if special standard of envelope is needed
- All standard envelope die-cutters can be downloaded at "Download" in the company website
- All the envelopes are produced with free seal adhesive, please indicate if customer has special requirements
- Envelopes are single-sided in colour printing, please seek for quotation for double-sided full colour printing when necessary

**Lead Time:** 4 working days, \* Collecting from branches + 1 working day  
(Except for items with finishing, start from the date when customers confirm the proof)  
\* + 1 day Non-Standard die-cutter, to be extended due to quantity

## Letterheads – 80 / 100g Woodfree Paper

A4 210 x 297mm	
Qty.	Price
<b>1,000 pcs</b>	\$300
<b>2,000 pcs</b>	\$400
<b>3,000 pcs</b>	\$500
<b>4,000 pcs</b>	\$600
<b>5,000 pcs</b>	\$700
<b>10,000 pcs</b>	\$1,200

- Prices above are based on the size (210 x 297mm)
- Paper Material: 80 / 100g Woodfree Paper
- Colour: 4C + 0
- Minimum order quantity: 1,000 pcs; 10,000 pcs or above, each piece is computed from \$0.12

**Lead Time:** 1 working day, \* Collecting from branches + 1 working day  
(Except for items with finishing, start from the date when customers confirm the proof)

**Available finishing:** Pad; Hole Drilling; Foil Stamping (Price is negotiable)

## Full Colour Envelopes / Letterheads

### Discount Packages – 100g Woodfree Paper

Package	Qty.	Price
<b>A</b> (1,000 sets)	Envelope 1,000 pcs (DL / 4 x 9") + Letterhead 1,000 pcs (Restricted within A4 size)	\$688
<b>B</b> (2,000 sets)	Envelope 2,000 pcs (DL / 4 x 9") + Letterhead 2,000 pcs (Restricted within A4 size)	\$888
<b>C</b> (500 sets)	Envelope 500 pcs (DL / 4 x 9") + Letterhead 500 pcs (Restricted within A4 size)	\$588

**Lead Time:** 4 working days  
(Except for items with finishing, start from the date when customers confirm the proof)  
\* + 1 day Non-Standard die-cutter, to be extended due to quantity

**Fees for "With Window":** + \$50 / 1,000 pcs

### Envelope Styles

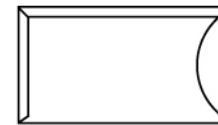

POCKET - ROUND FLAP

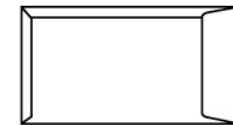

POCKET - FLAT FLAP



DIAMOND

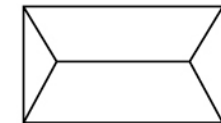

WALLET

Note: Please be aware that all the prices are subject to change without prior notice, please visit our website for the latest updates  
If finishing items are needed, please refer to page 95-109 for further details

## Spot Colour Envelopes – 100g Woodfree Paper

Envelope Styles	4 x 9" Pocket		4 x 9" Wallet		4.5 x 9.5" Pocket		DL Wallet 110 x 220mm		Add 1 Colour
	Type	Without Window	With Window	Without Window	With Window	Without Window	With Window	Without Window	
Qty.	1C + 0								
Colour	1C + 0								
1,000 pcs	\$230	\$250	\$250	\$270	\$280	\$280	\$240	\$260	\$100
2,000 pcs	\$400	\$440	\$440	\$480	\$460	\$500	\$420	\$460	\$170
3,000 pcs	\$590	\$650	\$650	\$710	\$680	\$740	\$620	\$680	\$230
4,000 pcs	\$770	\$850	\$850	\$930	\$890	\$970	\$810	\$890	\$290
5,000 pcs	\$950	\$1,050	\$1,050	\$1,150	\$1,100	\$1,200	\$1,000	\$1,100	\$360
6,000 pcs	\$1,120	\$1,240	\$1,240	\$1,360	\$1,300	\$1,420	\$1,180	\$1,300	\$390
7,000 pcs	\$1,300	\$1,440	\$1,440	\$1,580	\$1,510	\$1,650	\$1,370	\$1,510	\$440
8,000 pcs	\$1,470	\$1,630	\$1,630	\$1,790	\$1,710	\$1,870	\$1,550	\$1,710	\$490
9,000 pcs	\$1,630	\$1,810	\$1,810	\$1,990	\$1,900	\$2,080	\$1,720	\$1,900	\$540
10,000 pcs	\$1,810	\$2,010	\$2,010	\$2,210	\$2,110	\$2,310	\$1,910	\$2,110	\$590

- ONLY 100g woodfree paper can be applied to Spot Colour Envelopes; the Minimum Ordering Quantity is 1,000 pcs
- Printing Color: 1C + 0, 2C + 0, 3C + 0 \* (You can only choose between these C.M.Y.K. standard printing colours and 15 kinds of spot colours), if customer has special requirements, please seek for quotation
- \* 3C + 0 is only available for 2 kinds of spot colours and 1 type of standard colour from C.M.Y.K.
- Envelope Styles: 4 x 9" Pocket Style Envelope (With Window or Without Window), 4 x 9" Wallet Style Envelope (With Window or Without Window), 4.5 x 9.5" Pocket Style Envelope (With Window or Without Window), 110 x 220mm DL Wallet Style Envelope (With Window or Without Window), total 8 styles of envelope can be chosen
- All the envelopes are produced with seal adhesive, please indicate if customer has special requirements
- For non standard colour printing or special requirement, please seek for quotation and any special discount offer will not be enjoyed

### Artwork Specifications:

- The artwork should not be near the edges, these should be at least 10mm far away from the edges for the top part. For the side and bottom edges, there should be at least 5mm. All envelope templates can be downloaded at "Download Center" in the company website for customers to do the artwork
- Envelopes can not print "full screen" and "solid". Only simple logos and texts can be applied

### Lead Time: 2 working days

- \* Collecting from branches + 1 working day  
(Start from the date when customers confirm the proof)

## Spot Colour Envelopes / Letterheads

### Spot Colour Letterheads – 80 / 100g Woodfree Paper

A4 210 x 297mm		
Qty.	Single Colour	Add 1 Colour
1,000 pcs	\$190	\$90
2,000 pcs	\$260	\$100
3,000 pcs	\$380	\$120
4,000 pcs	\$490	\$140
5,000 pcs	\$600	\$160
6,000 pcs	\$720	\$180
7,000 pcs	\$840	\$200
8,000 pcs	\$960	\$220
9,000 pcs	\$1,080	\$240
10,000 pcs	\$1,200	\$260

- ONLY 80g / 100g woodfree paper can be applied to Spot Colour Letterheads; the Minimum Ordering Quantity is 1,000 pcs
- Printing Color: 1C + 0, 2C + 0, 1C + 1C, 2C + 1C, 2C + 2C

### Lead Time: 2 working days

- \* Collecting from branches + 1 working day  
(Start from the date when customers confirm the proof)

### Envelope Styles (Including With Window & Without Window)

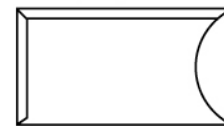

POCKET - ROUND FLAP

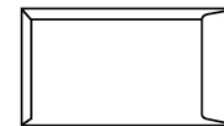

POCKET - FLAT FLAP

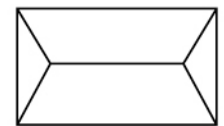

WALLET

Note: Please be aware that all the prices are subject to change without prior notice, please visit our website for the latest updates  
If finishing items are needed, please refer to page 95-109 for further details

## 140g Woodfree Paper

Pocket Style Envelope with Seal Adherence	Model A 9 x 12 1/8" 229 x 308mm		Model B 10 x 14" 254 x 355mm		
	Type	Without Window	With Window	Without Window	With Window
Qty.					
<b>1,000 pcs</b>		\$1,650	\$1,700	\$1,700	\$1,800
<b>2,000 pcs</b>		\$2,000	\$2,200	\$2,100	\$2,300
<b>3,000 pcs</b>		\$2,500	\$2,800	\$2,650	\$3,000
<b>4,000 pcs</b>		\$3,050	\$3,450	\$3,250	\$3,560
<b>5,000 pcs</b>		\$3,650	\$3,800	\$3,800	\$4,100
<b>10,000 pcs</b>		\$6,100	\$6,450	\$6,400	\$6,700

## Full Colour Document Envelopes

### 140g Woodfree Paper

Qty.	Model C 9 x 12 1/8" 229 x 308mm	Model D 10 x 14 x 1.5" 254 x 355 x 38mm
	Price	Price
<b>1,000 pcs</b>	\$1,850	\$1,900
<b>2,000 pcs</b>	\$2,350	\$2,500
<b>3,000 pcs</b>	\$3,050	\$3,200
<b>4,000 pcs</b>	\$3,800	\$4,000
<b>5,000 pcs</b>	\$4,500	\$4,750
<b>10,000 pcs</b>	\$8,200	\$8,700

- Prices above are subject to standard size and type merely, please contact us for quotation if there is any special requirement
- Paper Material of Document Envelope: 140g Woodfree Paper
- For standard die-cutter of Document Envelope, please visit our website [www.e-print.com.hk](http://www.e-print.com.hk), and download from "Download Center"

**Finishing items included:** Seal Adherence; Envelope Throat Flap

**Other available Finishing items:** Eyelet; Shirring

**Lead Time:** 11 working days

\* Collecting from branches + 1 working day

(Except for items with finishing, start from the date when customers confirm the proof)

Model A

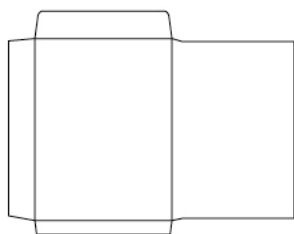

Pocket Style Envelope with Seal Adherence

Model B

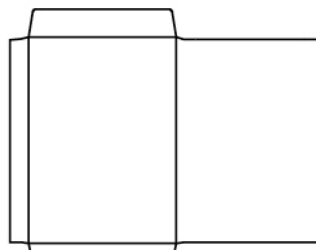

Model C

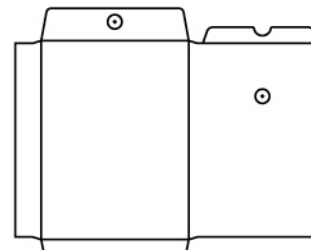

Chinese Type Envelope with Eyelet

Model D

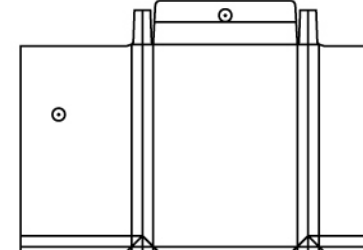

Accordion Envelope with Eyelet

Note: Please be aware that all the prices are subject to change without prior notice, please visit our website for the latest updates  
If finishing items are needed, please refer to page 95-109 for further details



## 420 x 297mm

	2 PLY	2 PLY add colour	3 PLY	3 PLY add colour	4 PLY	4 PLY add colour	5 PLY	5 PLY add colour
Colour Qty.	1C + 0	1 Colour	1C + 0	1 Colour	1C + 0	1 Colour	1C + 0	1 Colour
<b>10 pcs</b>	\$450	\$140	\$560	\$140	\$650	\$205	\$770	\$215
<b>20 pcs</b>	\$605	\$185	\$845	\$160	\$1,045	\$275	\$1,285	\$290
<b>30 pcs</b>	\$890	\$195	\$1,165	\$185	\$1,550	\$300	\$1,940	\$290
<b>40 pcs</b>	\$1,010	\$205	\$1,365	\$205	\$1,815	\$335	\$2,300	\$290
<b>50 pcs</b>	\$1,150	\$230	\$1,520	\$230	\$1,970	\$370	\$2,550	\$290
<b>100 pcs</b>	\$1,935	\$415	\$2,880	\$415	\$3,750	\$550	\$5,070	\$575
<b>200 pcs</b>	\$3,840	\$830	\$5,730	\$830	\$7,425	\$1,105	\$10,075	\$1,150
<b>300 pcs</b>	\$5,720	\$1,240	\$8,570	\$1,240	\$11,090	\$1,655	\$15,050	\$1,730
<b>400 pcs</b>	\$7,600	\$1,655	\$11,385	\$1,655	\$14,720	\$2,210	\$19,975	\$2,305

	2 PLY	3 PLY	4 PLY	5 PLY
Colour Qty.	4C + 0	4C + 0	4C + 0	4C + 0
<b>10 pcs</b>	\$870	\$980	\$1,265	\$1,415
<b>20 pcs</b>	\$1,160	\$1,325	\$1,870	\$2,155
<b>30 pcs</b>	\$1,475	\$1,720	\$2,450	\$2,885
<b>40 pcs</b>	\$1,625	\$1,980	\$2,820	\$3,170
<b>50 pcs</b>	\$1,800	\$2,210	\$3,080	\$3,720
<b>100 pcs</b>	\$3,180	\$4,125	\$5,400	\$6,795
<b>200 pcs</b>	\$6,330	\$8,220	\$10,740	\$13,525
<b>300 pcs</b>	\$9,440	\$12,290	\$16,055	\$20,240
<b>400 pcs</b>	\$12,565	\$16,350	\$21,350	\$26,890

## NCR Invoices / Receipt Booklets

### 368 x 203mm

	2 PLY	2 PLY add colour	3 PLY	3 PLY add colour	4 PLY	4 PLY add colour	5 PLY	5 PLY add colour
Colour Qty.	1C + 0	1 Colour	1C + 0	1 Colour	1C + 0	1 Colour	1C + 0	1 Colour
<b>10 pcs</b>	\$385	\$140	\$460	\$140	\$605	\$205	\$735	\$215
<b>20 pcs</b>	\$495	\$185	\$635	\$185	\$845	\$275	\$1,090	\$290
<b>30 pcs</b>	\$735	\$195	\$970	\$195	\$1,275	\$300	\$1,595	\$290
<b>40 pcs</b>	\$860	\$205	\$1,160	\$205	\$1,465	\$335	\$1,825	\$290
<b>50 pcs</b>	\$935	\$230	\$1,275	\$230	\$1,615	\$370	\$2,055	\$290
<b>100 pcs</b>	\$1,585	\$415	\$2,300	\$415	\$2,675	\$550	\$3,135	\$575
<b>200 pcs</b>	\$3,135	\$830	\$4,665	\$830	\$5,280	\$1,105	\$6,235	\$1,150
<b>300 pcs</b>	\$4,675	\$1,240	\$6,775	\$1,240	\$7,865	\$1,655	\$9,315	\$1,730
<b>400 pcs</b>	\$6,180	\$1,655	\$8,985	\$1,655	\$10,430	\$2,210	\$12,340	\$2,305

	2 PLY	3 PLY	4 PLY	5 PLY
Colour Qty.	4C + 0	4C + 0	4C + 0	4C + 0
<b>10 pcs</b>	\$805	\$860	\$1,220	\$1,380
<b>20 pcs</b>	\$1,050	\$1,160	\$1,670	\$1,960
<b>30 pcs</b>	\$1,320	\$1,445	\$2,175	\$2,465
<b>40 pcs</b>	\$1,475	\$1,585	\$2,470	\$2,695
<b>50 pcs</b>	\$1,625	\$1,855	\$2,725	\$3,150
<b>100 pcs</b>	\$2,830	\$3,520	\$4,325	\$4,860
<b>200 pcs</b>	\$5,625	\$7,155	\$8,595	\$9,685
<b>300 pcs</b>	\$8,395	\$10,495	\$12,830	\$14,505
<b>400 pcs</b>	\$11,145	\$13,950	\$17,060	\$19,255

## 215 x 297mm (A4)

	2 PLY	2 PLY add colour	3 PLY	3 PLY add colour	4 PLY	4 PLY add colour	5 PLY	5 PLY add colour
Colour Qty.	1C + 0	1 Colour	1C + 0	1 Colour	1C + 0	1 Colour	1C + 0	1 Colour
10 pcs	\$340	\$115	\$420	\$125	\$455	\$195	\$530	\$205
20 pcs	\$450	\$115	\$640	\$125	\$730	\$195	\$895	\$205
30 pcs	\$640	\$115	\$885	\$130	\$1,090	\$195	\$1,340	\$205
40 pcs	\$705	\$115	\$1,045	\$140	\$1,260	\$195	\$1,595	\$205
50 pcs	\$770	\$115	\$1,095	\$140	\$1,430	\$195	\$1,770	\$205
100 pcs	\$1,310	\$230	\$2,035	\$255	\$2,695	\$390	\$3,515	\$410
200 pcs	\$2,480	\$460	\$3,980	\$505	\$5,165	\$780	\$6,980	\$815
300 pcs	\$3,670	\$685	\$5,945	\$755	\$7,690	\$1,175	\$10,445	\$1,225
400 pcs	\$4,855	\$915	\$7,900	\$1,005	\$10,195	\$1,565	\$13,855	\$1,630

	2 PLY	3 PLY	4 PLY	5 PLY
Colour Qty.	4C + 0	4C + 0	4C + 0	4C + 0
10 pcs	\$720	\$795	\$1,040	\$1,145
20 pcs	\$860	\$1,015	\$1,315	\$1,510
30 pcs	\$1,020	\$1,275	\$1,675	\$1,955
40 pcs	\$1,090	\$1,465	\$1,845	\$2,210
50 pcs	\$1,200	\$1,515	\$2,015	\$2,385
100 pcs	\$2,000	\$2,800	\$3,865	\$4,745
200 pcs	\$3,760	\$5,495	\$7,505	\$9,425
300 pcs	\$5,455	\$8,210	\$11,215	\$14,120
400 pcs	\$7,125	\$10,915	\$14,890	\$18,745

## NCR Invoices / Receipt Booklets

### 215 x 190mm

	2 PLY	2 PLY add colour	3 PLY	3 PLY add colour	4 PLY	4 PLY add colour	5 PLY	5 PLY add colour
Colour Qty.	1C + 0	1 Colour	1C + 0	1 Colour	1C + 0	1 Colour	1C + 0	1 Colour
10 pcs	\$320	\$115	\$390	\$125	\$430	\$195	\$515	\$205
20 pcs	\$375	\$115	\$470	\$125	\$590	\$195	\$765	\$205
30 pcs	\$530	\$115	\$655	\$135	\$890	\$195	\$1,110	\$205
40 pcs	\$605	\$115	\$750	\$140	\$1,020	\$195	\$1,275	\$205
50 pcs	\$650	\$115	\$840	\$140	\$1,135	\$195	\$1,440	\$205
100 pcs	\$1,060	\$230	\$1,585	\$225	\$2,020	\$390	\$2,505	\$410
200 pcs	\$2,045	\$460	\$3,150	\$505	\$3,730	\$780	\$4,845	\$815
300 pcs	\$3,005	\$685	\$4,705	\$755	\$5,565	\$1,175	\$7,190	\$1,225
400 pcs	\$3,965	\$915	\$6,235	\$1,005	\$7,405	\$1,565	\$9,545	\$1,630

	2 PLY	3 PLY	4 PLY	5 PLY
Colour Qty.	4C + 0	4C + 0	4C + 0	4C + 0
10 pcs	\$710	\$765	\$1,015	\$1,130
20 pcs	\$785	\$845	\$1,175	\$1,380
30 pcs	\$930	\$1,060	\$1,475	\$1,725
40 pcs	\$1,005	\$1,170	\$1,605	\$1,890
50 pcs	\$1,100	\$1,260	\$1,720	\$2,055
100 pcs	\$1,840	\$2,350	\$3,190	\$3,735
200 pcs	\$3,380	\$4,665	\$6,070	\$7,290
300 pcs	\$4,870	\$6,970	\$9,090	\$10,865
400 pcs	\$6,355	\$9,250	\$12,100	\$14,435

## 215 x 146mm (A5)

	2 PLY	2 PLY add colour	3 PLY	3 PLY add colour	4 PLY	4 PLY add colour	5 PLY	5 PLY add colour
Colour Qty.	1C + 0	1 Colour	1C + 0	1 Colour	1C + 0	1 Colour	1C + 0	1 Colour
<b>10 pcs</b>	\$265	\$105	\$365	\$115	\$380	\$195	\$500	\$205
<b>20 pcs</b>	\$330	\$105	\$425	\$115	\$500	\$195	\$660	\$205
<b>30 pcs</b>	\$450	\$105	\$595	\$125	\$690	\$195	\$865	\$205
<b>40 pcs</b>	\$505	\$105	\$705	\$125	\$810	\$195	\$1,050	\$205
<b>50 pcs</b>	\$585	\$105	\$800	\$125	\$945	\$195	\$1,110	\$205
<b>100 pcs</b>	\$970	\$190	\$1,260	\$205	\$1,595	\$310	\$1,890	\$325
<b>200 pcs</b>	\$1,870	\$380	\$2,505	\$420	\$3,165	\$615	\$3,725	\$640
<b>300 pcs</b>	\$2,785	\$570	\$3,725	\$625	\$4,715	\$925	\$5,575	\$965
<b>400 pcs</b>	\$3,660	\$760	\$4,940	\$835	\$6,250	\$1,225	\$7,380	\$1,280

	2 PLY	3 PLY	4 PLY	5 PLY
Colour Qty.	4C + 0	4C + 0	4C + 0	4C + 0
<b>10 pcs</b>	\$675	\$710	\$965	\$1,115
<b>20 pcs</b>	\$725	\$770	\$1,085	\$1,275
<b>30 pcs</b>	\$845	\$970	\$1,275	\$1,480
<b>40 pcs</b>	\$920	\$1,080	\$1,395	\$1,665
<b>50 pcs</b>	\$995	\$1,175	\$1,530	\$1,725
<b>100 pcs</b>	\$1,350	\$1,900	\$2,525	\$2,865
<b>200 pcs</b>	\$2,630	\$3,765	\$5,010	\$5,645
<b>300 pcs</b>	\$3,925	\$5,600	\$7,490	\$8,470
<b>400 pcs</b>	\$5,180	\$7,445	\$9,925	\$11,220

## NCR Invoices / Receipt Booklets

### 190 x 106mm

	2 PLY	2 PLY add colour	3 PLY	3 PLY add colour	4 PLY	4 PLY add colour	5 PLY	5 PLY add colour
Colour Qty.	1C + 0	1 Colour	1C + 0	1 Colour	1C + 0	1 Colour	1C + 0	1 Colour
<b>10 pcs</b>	\$265	\$105	\$365	\$115	\$380	\$195	\$490	\$205
<b>20 pcs</b>	\$330	\$105	\$425	\$115	\$500	\$195	\$600	\$205
<b>30 pcs</b>	\$395	\$105	\$550	\$115	\$600	\$195	\$730	\$205
<b>40 pcs</b>	\$450	\$105	\$580	\$115	\$770	\$195	\$860	\$205
<b>50 pcs</b>	\$530	\$105	\$675	\$120	\$895	\$195	\$1,080	\$205
<b>100 pcs</b>	\$825	\$105	\$1,000	\$125	\$1,330	\$195	\$1,655	\$205
<b>200 pcs</b>	\$1,205	\$190	\$1,760	\$205	\$2,020	\$310	\$2,515	\$325
<b>300 pcs</b>	\$1,780	\$295	\$2,625	\$320	\$2,985	\$450	\$3,685	\$470
<b>400 pcs</b>	\$2,325	\$380	\$3,470	\$420	\$4,090	\$615	\$4,850	\$640

	2 PLY	3 PLY	4 PLY	5 PLY
Colour Qty.	4C + 0	4C + 0	4C + 0	4C + 0
<b>10 pcs</b>	\$675	\$710	\$965	\$1,105
<b>20 pcs</b>	\$725	\$770	\$1,085	\$1,215
<b>30 pcs</b>	\$805	\$895	\$1,185	\$1,345
<b>40 pcs</b>	\$860	\$925	\$1,355	\$1,425
<b>50 pcs</b>	\$995	\$1,035	\$1,480	\$1,695
<b>100 pcs</b>	\$1,250	\$1,375	\$1,915	\$2,270
<b>200 pcs</b>	\$1,795	\$2,375	\$2,950	\$3,490
<b>300 pcs</b>	\$2,590	\$3,585	\$4,335	\$5,095
<b>400 pcs</b>	\$3,315	\$4,730	\$5,935	\$6,770

## 139 x 106mm

	2 PLY	2 PLY add colour	3 PLY	3 PLY add colour	4 PLY	4 PLY add colour	5 PLY	5 PLY add colour
Colour Qty.	1C + 0	1 Colour	1C + 0	1 Colour	1C + 0	1 Colour	1C + 0	1 Colour
10 pcs	\$265	\$105	\$340	\$115	\$370	\$195	\$490	\$205
20 pcs	\$320	\$105	\$425	\$115	\$490	\$195	\$590	\$205
30 pcs	\$350	\$105	\$450	\$115	\$530	\$195	\$660	\$205
40 pcs	\$375	\$105	\$505	\$115	\$580	\$195	\$710	\$205
50 pcs	\$440	\$105	\$530	\$125	\$675	\$195	\$840	\$205
100 pcs	\$660	\$105	\$945	\$125	\$1,000	\$195	\$1,250	\$205
200 pcs	\$1,130	\$190	\$1,425	\$205	\$1,655	\$310	\$1,990	\$325
300 pcs	\$1,650	\$295	\$2,125	\$320	\$2,480	\$450	\$2,985	\$470
400 pcs	\$2,155	\$380	\$2,795	\$420	\$3,285	\$585	\$3,955	\$610

	2 PLY	3 PLY	4 PLY	5 PLY
Colour Qty.	4C + 0	4C + 0	4C + 0	4C + 0
10 pcs	\$660	\$685	\$955	\$1,105
20 pcs	\$710	\$770	\$1,075	\$1,205
30 pcs	\$765	\$795	\$1,115	\$1,275
40 pcs	\$785	\$850	\$1,165	\$1,325
50 pcs	\$860	\$905	\$1,260	\$1,455
100 pcs	\$1,045	\$1,320	\$1,585	\$1,865
200 pcs	\$1,575	\$2,040	\$2,585	\$2,965
300 pcs	\$2,240	\$3,085	\$3,830	\$4,395
400 pcs	\$2,915	\$4,055	\$5,040	\$5,785

## NCR Invoices / Receipt Booklets

- Available designs of NCR Invoice Booklet in each industry can be downloaded from our website [www.e-print.com.hk](http://www.e-print.com.hk)
- Available colours of numbers are red and black. (For other colours, please seek for quotation when ordering)
- Available designs for NCR Invoice Booklet of industries: Chinese Style; Beauty; Watches and Jewellery; Clothing; Ordering; Eye-wear and Optometry; Trading and Engineering; Logistics; Retail and Wholesale.

### NCR: Notice 1

- Standard Printing Color: Black / 15 pantone colours (Prices for other colours will be charged as double) (Remarks: Black / Specific pantone colour 2C + 0, will be counted as 3C + 0)
- Standard Paper Color Sequence: 2 PLY: White Front / Red Bottom  
3 PLY: White Front / Red 2nd / Yellow Bottom  
4 PLY: White Front / Red 2nd / Yellow 3rd / Blue Bottom  
5 PLY: White Front / Red 2nd / Yellow 3rd / Blue 4th / Green Bottom
- Change paper colour Sequence:  
White Front (Unchanged), change in sequence and colour of paper: Total Amount of ordering: +\$60  
White Front (Changed), change in sequence and colour of paper: Total Amount of ordering: +40% (Extra lead time: + 2 working days)
- Change to Woodfree Paper: For 80 and 100g Woodfree Paper, price will be set as total amount of NCR price +\$50 (Price Negotiable for bulk purchase)
- NCR Paper is thinner than Woodfree Paper, its elasticity is weaker than Double-sided Coated Art Paper. General full colour invoice booklets are always attached with full-coloured logo and light background. (Paper with 100% colour density will lead to opacity for "writing", please be aware of keeping 50% colour density or below)
- No. of set for an invoice booklet is 50, customers can change to 25 sets or 100 sets, \$20 will be charged for every 1,000 sets (Minimum charge \$50). Note: For 2 PLY above, price is counted as double
- There will also be double book counting for 2 PLY or more
- The standard printing colour is in black and 15 kinds of spot colour. Any other colour will be charged as double colours.

### NCR: Notice 2

- Special Perforation: For special position (Except for half inch), it will be charged +\$100 for the first perforation, afterwards it will be charged \$50 for each perforation (Extra lead time: + 1 working day). Note: Normal perforation only attach within 5 standard sizes
  - Addition of Numbering: +\$60 / set; Addition of Numbering in black ink total amount +\$70 / set
  - Change of Plate: Addition of each plate +\$60, counted with one colour
  - White bottom (opacity): +\$100, counted with one colour
  - Auto - Resolving Gel: +\$30 / 1,000 sets (Minimum charge \$50)
- (Prices above are determined by customers' own artwork, including 1 set of number)

### Notice when ordering:

- Pad Position (Top or Left)
- Perforation Position
- Stapling (Top or Left)

### Artwork Editing Service:

- Information editing +\$50
- Addition of logo or trademark +\$150 (Design excluded)

### Lead Time: 3 working days

(Except for items with finishing, start from the date when customers confirm the proof)

Note: Please be aware that all the prices are subject to change without prior notice, please visit our website for the latest updates  
If finishing items are needed, please refer to page 95-109 for further details

## Full Colour Coupons / Tickets

297 x 100mm					
Series	2-A	2-B	2-C	2-D	2-E
Type Qty.	1 set No. Standard font	1 perforation 2 sets No. Standard font	2 perforations 3 sets No. Standard font	1 perforation 2 sets No. Special font	2 perforations 3 sets No. Special font
500 pcs	\$410	\$500	\$560	\$570	\$650
1,000 pcs	\$460	\$550	\$620	\$630	\$700
2,000 pcs	\$520	\$610	\$670	\$680	\$760
3,000 pcs	\$740	\$860	\$900	\$1,010	\$1,070
4,000 pcs	\$800	\$900	\$1,030	\$1,050	\$1,110
5,000 pcs	\$980	\$1,090	\$1,140	\$1,290	\$1,350

210 x 95mm					
Series	3-A	3-B	3-C	3-D	3-E
Type Qty.	1 set No. Standard font	1 perforation 2 sets No. Standard font	2 perforations 3 sets No. Standard font	1 perforation 2 sets No. Special font	2 perforations 3 sets No. Special font
500 pcs	\$410	\$500	\$560	\$570	\$650
1,000 pcs	\$460	\$550	\$620	\$630	\$700
2,000 pcs	\$520	\$610	\$670	\$680	\$760
3,000 pcs	\$520	\$610	\$670	\$690	\$760
4,000 pcs	\$800	\$900	\$920	\$1,050	\$1,110
5,000 pcs	\$810	\$900	\$970	\$1,060	\$1,130

145 x 100mm 210 x 70mm				100 x 95mm 210 x 45mm		
Series	4-A	4-B	4-D	6-A	6-B	6-D
Type Qty.	1 set No. Standard font	1 perforation 2 sets No. Standard font	1 perforation 2 sets No. Special font	1 set No. Standard font	1 perforation 2 sets No. Standard font	1 perforation 2 sets No. Special font
500 pcs	\$410	\$500	\$570	\$410	\$500	\$570
1,000 pcs	\$430	\$510	\$580	\$430	\$510	\$580
2,000 pcs	\$480	\$540	\$620	\$480	\$540	\$620
3,000 pcs	\$480	\$590	\$680	\$480	\$580	\$670
4,000 pcs	\$540	\$750	\$830	\$540	\$640	\$830
5,000 pcs	\$810	\$900	\$1,050	\$580	\$830	\$900

- Numbering can only be single colour printed on one side
- Available colours for numbers are red, black and silver (For other colours, please seek for quotation and indicate when ordering)
- Please indicate the size of numbers when ordering, and ascertain that there is sufficient margin for placing numbers, we will not be responsible for any error caused
- Finished goods will simultaneously show the wording "No." as well as the numbers, for special word font of "No.", customers should design on their own draft and indicate that only numbers should be printed on finished goods. Prices are referred to series D and E
- If other paper material is required for product type 2, 3, 4 and 6, prices are shown as below:  
157g Gloss Art Paper: +\$15 / 1,000 pcs  
210g Gloss Art Board: +\$30 / 1,000 pcs  
250g Gloss Art Board: +\$45 / 1,000 pcs (Paper Material with 210g above, price for both sides x 1.3)  
(157g paper or below, prices are the same for single-sided and double-sided printing)
- For special design and size of ticket, please seek for quotation from us

**Lead Time: 2 working days (128g, 157g Gloss Art Paper)**

\* + 1 day for Woodfree paper, Matt Art Paper and Double-sided Coated Art Paper  
(Except for items with finishing, start from the date when customers confirm the proof)

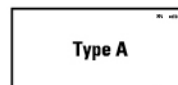

No limit for numbering

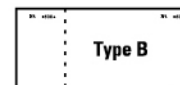

Leave sufficient margin for perforation and numbering

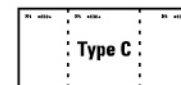

Leave sufficient margin for perforation and numbering

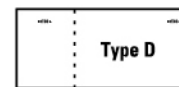

No limit for perforation or numbering

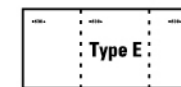

No limit for perforation or numbering

Note: Please be aware that all the prices are subject to change without prior notice, please visit our website for the latest updates

If finishing items are needed, please refer to page 95-109 for further details

## Security Fragile Label

Qty.	25 x 25mm			55 x 55mm			63 x 63mm		
	1C + 0	2C + 0	1 Colour Foiling	1C + 0	2C + 0	1 Colour Foiling	1C + 0	2C + 0	1 Colour Foiling
1,000 pcs	\$340	\$430	\$370	\$650	\$740	\$650	\$880	\$970	\$770
2,000 pcs	\$460	\$550	\$650	\$1,030	\$1,120	\$1,160	\$1,460	\$1,550	\$1,250
3,000 pcs	\$580	\$670	\$900	\$1,430	\$1,520	\$1,650	\$2,050	\$2,130	\$1,740
4,000 pcs	\$630	\$710	\$1,040	\$1,650	\$1,730	\$1,920	\$2,390	\$2,470	\$2,020
5,000 pcs	\$740	\$820	\$1,260	\$2,010	\$2,090	\$2,370	\$2,930	\$3,010	\$2,460
6,000 pcs	\$850	\$930	\$1,470	\$2,360	\$2,440	\$2,780	\$3,460	\$3,540	\$2,900
7,000 pcs	\$960	\$1,040	\$1,670	\$2,720	\$2,800	\$3,200	\$3,990	\$4,070	\$3,340
8,000 pcs	\$1,060	\$1,140	\$1,870	\$3,070	\$3,150	\$3,610	\$4,520	\$4,600	\$3,780
9,000 pcs	\$1,170	\$1,250	\$2,080	\$3,430	\$3,510	\$4,040	\$5,060	\$5,140	\$4,220
10,000 pcs	\$1,280	\$1,360	\$2,280	\$3,780	\$3,860	\$4,460	\$5,590	\$5,670	\$4,660

- The price of Security Fragile Label including ONE general geometry die-cutter
- Own die-cutter will not be accepted; other special die-cutter production, please contact us for enquiry (Please provide die-cutter layout to produce)
- 7 working days lead time when there is no lamination on security fragile paper
- Each Security Fragile Label only accept one foiling color
- Security Fragile Label only accept up to 2 colors in CMYK, 15 types of designated spot color (accept up to 2 colors)
- Customers are required to quote separately when you print more than 10,000pcs Security Fragile Label
- The smallest size of Security Fragile Label is 5 x 5mm, the largest size is 63 x 63mm
- Customers should provide the actual die-cut size of special label. The price of special labels will count as the nearest price of standard size
- The designed lines of Security Fragile Label minimum 0.5pt. or above
- Only ONE general geometry in a piece of Security Fragile Label, customers are required to quote separately if there are more than ONE general geometry
- Please visit our branches for more information

**Lead Time: 7 working days**

- \* Collecting from branches + 1 working day  
(Start from the date when customers confirm the proof)

## Special Labels

### Transparent, Matt Gold, Matt Silver Foil Labels

Qty.	25 x 25mm			55 x 55mm			63 x 63mm		
	1C + 0	2C + 0	1 Colour Foiling	1C + 0	2C + 0	1 Colour Foiling	1C + 0	2C + 0	1 Colour Foiling
1,000 pcs	\$260	\$350	\$310	\$350	\$440	\$390	\$430	\$520	\$770
2,000 pcs	\$310	\$400	\$530	\$440	\$530	\$650	\$570	\$660	\$1,270
3,000 pcs	\$350	\$430	\$720	\$540	\$630	\$870	\$720	\$800	\$1,700
4,000 pcs	\$360	\$440	\$800	\$570	\$650	\$1,000	\$780	\$860	\$1,900
5,000 pcs	\$400	\$480	\$970	\$660	\$740	\$1,200	\$910	\$990	\$2,290
6,000 pcs	\$440	\$520	\$1,110	\$740	\$820	\$1,380	\$1,040	\$1,120	\$2,670
7,000 pcs	\$480	\$560	\$1,260	\$830	\$910	\$1,560	\$1,170	\$1,250	\$3,030
8,000 pcs	\$520	\$600	\$1,400	\$910	\$990	\$1,740	\$1,300	\$1,380	\$3,370
9,000 pcs	\$560	\$640	\$1,560	\$1,000	\$1,080	\$1,940	\$1,430	\$1,510	\$3,680
10,000 pcs	\$600	\$680	\$1,700	\$1,080	\$1,160	\$2,120	\$1,560	\$1,640	\$4,000

- The price of label including transparent, matt gold, matt silver foil and ONE general geometry die-cutter (no lamination & special die-cutters are negotiable)
- Own die-cutter will not be accepted; other special die-cutter production, please contact us for enquiry (Please provide die-cutter layout to produce)
- Same price for Transparent, Matt Gold, Matt Silver Foil Label
- Transparent, Matt Gold, Matt Silver Foil Label only accept 1 type of Foil Stamping
- Transparent, Matt Gold, Matt Silver Foil Label only accept up to 2 colors in CMYK, 15 types of designated spot color (accept up to 2 colors)
- Customers are required to quote separately when you print more than 10,000 pcs Transparent, Matt Gold, Matt Silver Foil Label
- The smallest size of Transparent, Matt Gold, Matt Silver Foil Label is 5 x 5mm, the largest size is 63 x 63mm
- The designed lines of Security Fragile Label minimum 0.5pt. or above
- Only ONE general geometry in a piece of Transparent, Matt Gold, Matt Silver Foil Label, customers are required to quote separately if there are more than ONE general geometry
- Please visit our branches for more information

**Lead Time: 4 working days**

- \* Collecting from branches + 1 working day
- \* Foil Stamping + 1 working day
- \* No lamination + 7 working day  
(Start from the date when customers confirm the proof)

Note: Please be aware that all the prices are subject to change without prior notice, please visit our website for the latest updates

## Full Colour Labels / Stickers

### Standard die-cutter

Model	Model A	Model B	Model C	Model D	Model E	Model S
Sheet for Sticker	within 92 x 56 mm	within 92 x 112 mm	within 184 x 56 mm	within 92 x 168 mm	within 184 x 112 mm	within 127 x 254 mm
Qty.						
<b>100 sheets</b>	\$185	\$310		Minimum Order Quantities: 500 pcs		\$485
<b>200 sheets</b>	\$210	\$350				\$550
<b>300 sheets</b>	\$230	\$405				\$605
<b>500 sheets</b>	\$240	\$430		\$605	\$670	\$670
<b>1,000 sheets</b>	\$365	\$485		\$725	\$790	\$790
<b>2,000 sheets</b>	\$460	\$670		\$1,165	\$1,200	\$1,200
<b>3,000 sheets</b>	\$550	\$845		\$1,395	\$1,505	\$1,505
<b>4,000 sheets</b>	\$640	\$1,035		\$1,630	\$1,740	\$1,740
<b>5,000 sheets</b>	\$725	\$1,210		\$1,860	\$1,970	\$1,970

- Price are the same for Gloss / Woodfree surface
- Quantity of labels / stickers are based on the printing file (Qty. on each file x number of sheets = Total goods Qty.)
- Prices above include the cost of kiss-cut for standard die-cutter (Model A-S), please seek for quotation for files with different size, shape or composition (customized label)
- Minimum and maximum sizes of full label sheet are 45 x 54mm and 480 x 310mm respectively, please note the sizes for customized label
- Charge of die-cutter is based on geometry shapes (Circular Shape, Rectangular Shape with Round Angle, Oval Shape, Triangle Shape, and Trapezium Shape). Price will be varied in terms of irregular shape
- Own die-cutter will not be accepted; other special die-cutter production, please contact us for enquiry (Please provide die-cutter layout to produce)
- Standard die-cutters with different sizes and shapes can be downloaded from our website [www.e-print.com.hk](http://www.e-print.com.hk)

#### Lead Time: 3 working days

- \* + 1 day for Non- standard die-cutter, to be extended due to quantity  
(Except for items with finishing, start from the date when customers confirm the proof)

Note: Please be aware that all the prices are subject to change without prior notice, please visit our website for the latest updates  
If finishing items are needed, please refer to page 95-109 for further details

## Plastic Folders

### Gloss / Matt Plastic Folder

Qty.	Model	PP01 - PP03	PP04 - PP06
<b>500 pcs</b>		\$1,920	Minimum Order Quantities: 1,000 pcs
<b>1,000 pcs</b>		\$3,000	\$4,080
<b>2,000 pcs</b>		\$5,600	\$7,560
<b>3,000 pcs</b>		\$7,780	\$10,980
<b>4,000 pcs</b>		\$9,940	\$14,160
<b>5,000 pcs</b>		\$11,580	\$17,100

### Frosting + Spot UV Plastic folder

Qty.	Model	PP01 - PP03 ONLY
<b>2,000 pcs</b>		\$6,840
<b>3,000 pcs</b>		\$9,720
<b>4,000 pcs</b>		\$12,480
<b>5,000 pcs</b>		\$15,000

- Printing material: 0.2PP plastic
- Packaging Medium: Cartons; Individual Packaging in plastic bag +\$0.4 / each (+ 1-2 working days)
- If the size and type of customers' design are different from standard die-cutters provided by e-print, please seek for quotation
- Own die-cutter will not be accepted; other special die-cutter production, please contact us for enquiry (Please provide die-cutter layout to produce)

#### Lead Time: 5 working days (PP01-PP03)

#### 7 working days (PP04-PP06)

- \* Collecting from branches + 1 working day
- \* Folder with Frosting & Spot UV: + 1 working day
- \* Lead time to be confirmed with our staff for non- standard die-cutting

Note: Please be aware that all the prices are subject to change without prior notice, please visit our website for the latest updates  
If finishing items are needed, please refer to page 95-109 for further details

## PP Folder die-cutter

**Model PP01 Die-Cutter**

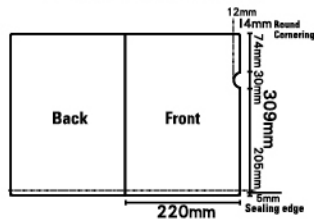

Finished Size : 220 x 309mm  
Rounded Corner : 4mm

**Model PP02 Die-Cutter**

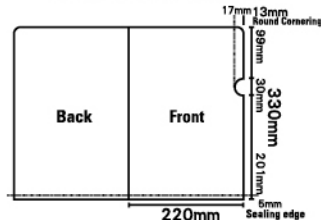

Finished Size : 220 x 330mm  
Rounded Corner : 13mm

**Model PP03 Die-Cutter**

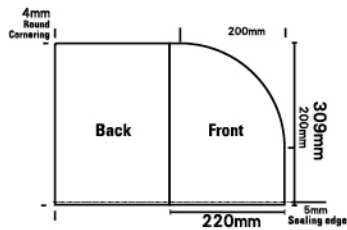

Finished Size : 220 x 309mm  
Rounded Corner : 200mm

**Model PP04 Die-Cutter**

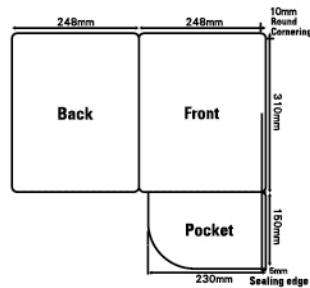

Finished Size : 248 x 310mm  
Rounded Corner : 10mm

**Model PP05 Die-Cutter**

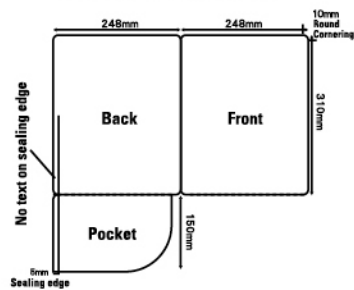

Finished Size : 248 x 310m  
Rounded Corner : 10mm

**Model PP06 Die-Cutter**

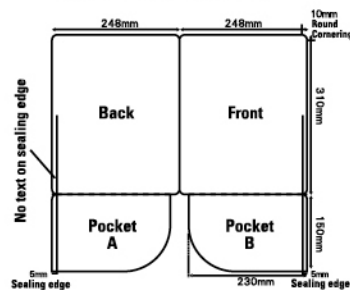

Finished Size : 248 x 310m  
Rounded Corner : 10mm

Note: Texts are recommended to place above the bottom edge for 10mm, lest the sealing edge would cover the wordings

## Preparing File for Plastic Folder

- Regarding the standard die-cutter of full-coloured folder, please visit our website [www.e-print.com.hk](http://www.e-print.com.hk)
- Texts should be outlined, and resolution of graphic should be 300-350 dpi



Same as general artwork design, texts should be outlined, resolution of graphic should be 300-350 dpi, and set the colour mode in CMYK

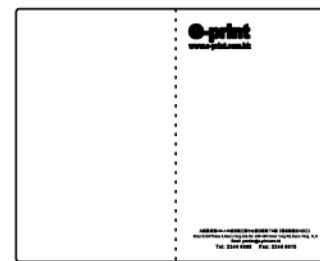

As the plastic folder is transparent, to avoid that in certain area, please highlight the proposed area with 5th 100% black colour, method would be the same as spot UV

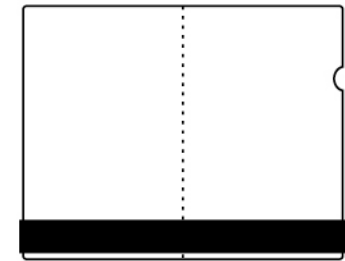



## Series A / B 250g Gloss Art Board

Type Qty.	Series A		Series B		Single-Sided Lamination		Single-Sided Varnish
	4C + 0	4C + 4C	4C + 0	4C + 4C	Gloss	Matt	Gloss / Matt
500 pcs	\$5.00	\$6.80	\$4.90	\$6.70	+\$200	+\$400	+\$300
1,000 pcs	\$3.00	\$3.90	\$2.85	\$3.75	+\$320	+\$520	+\$300
2,000 pcs	\$2.03	\$2.48	\$1.90	\$2.35	+\$640	+\$1,030	+\$300
3,000 pcs	\$1.78	\$2.13	\$1.65	\$2.00	+\$880	+\$1,440	+\$450
4,000 pcs	\$1.66	\$1.96	\$1.53	\$1.83	+\$1,200	+\$1,880	+\$600
5,000 pcs	\$1.60	\$1.88	\$1.47	\$1.74	+\$1,440	+\$2,360	+\$750

## Series C / D 250g Gloss Art Board

Type Qty.	Series C		Series D		Single-Sided Lamination		Single-Sided Varnish
	4C + 0	4C + 4C	4C + 0	4C + 4C	Gloss	Matt	Gloss / Matt
500 pcs	\$5.53	\$7.33	\$5.39	\$7.19	+\$200	+\$400	+\$300
1,000 pcs	\$3.28	\$4.18	\$3.16	\$4.06	+\$356	+\$570	+\$300
2,000 pcs	\$2.21	\$2.66	\$2.10	\$2.55	+\$713	+\$1,140	+\$300
3,000 pcs	\$1.92	\$2.27	\$1.82	\$2.17	+\$1,069	+\$1,710	+\$450
4,000 pcs	\$1.80	\$2.10	\$1.70	\$2.00	+\$1,425	+\$2,280	+\$600
5,000 pcs	\$1.73	\$2.00	\$1.63	\$1.90	+\$1,781	+\$2,850	+\$750

## Full Colour Paper Folders

### Series E / F 250g Gloss Art Board

Type Qty.	Series E		Series F		Single-Sided Lamination		Single-Sided Varnish
	4C + 0	4C + 4C	4C + 0	4C + 4C	Gloss	Matt	Gloss / Matt
500 pcs	\$5.36	\$7.16	\$5.01	\$6.81	+\$200	+\$400	+\$300
1,000 pcs	\$3.13	\$4.03	\$2.83	\$3.73	+\$320	+\$520	+\$300
2,000 pcs	\$2.07	\$2.52	\$1.78	\$2.23	+\$640	+\$1,030	+\$300
3,000 pcs	\$1.80	\$2.15	\$1.50	\$1.85	+\$880	+\$1,440	+\$450
4,000 pcs	\$1.68	\$1.98	\$1.39	\$1.69	+\$1,200	+\$1,880	+\$600
5,000 pcs	\$1.61	\$1.88	\$1.32	\$1.59	+\$1,440	+\$2,360	+\$750

### Series G / H 250g Gloss Art Board

Type Qty.	Series G		Series H		Single-Sided Lamination		Single-Sided Varnish
	4C + 0	4C + 4C	4C + 0	4C + 4C	Gloss	Matt	Gloss / Matt
500 pcs	\$7.13	\$9.53	\$8.09	\$10.49	+\$308	+\$494	+\$500
1,000 pcs	\$4.40	\$5.60	\$5.14	\$6.34	+\$617	+\$987	+\$500
2,000 pcs	\$3.08	\$3.68	\$3.71	\$4.31	+\$1,234	+\$1,974	+\$500
3,000 pcs	\$2.68	\$3.08	\$3.25	\$3.65	+\$1,851	+\$2,961	+\$750
4,000 pcs	\$2.50	\$2.80	\$3.05	\$3.35	+\$2,468	+\$3,948	+\$1,000
5,000 pcs	\$2.43	\$2.71	\$2.98	\$3.26	+\$3,084	+\$4,935	+\$1,250

- Prices above are computed in unit price; prices for single-sided lamination and varnishing would be computed in total price
- For double-sided lamination or varnishing, please seek for quotation
- If pocket inside folder has spine, please seek for quotation
- For any Non-Standard die-cutter, customer must seek for quotation
- Own die-cutter will not be accepted; other special die-cutter production, please contact us for enquiry (Please provide die-cutter layout to produce)
- Regarding the standard die-cutter, please visit our website [www.e-print.com.hk](http://www.e-print.com.hk)

**Lead Time:** 4 working days (Series A-G)  
 5 working days (Series H)  
 \* + 1 day for Non-Standard die-cutter, to be extended due to the quantity  
 (Except for items with finishing, start from the date when customers confirm the proof)

Note: Please be aware that all the prices are subject to change without prior notice, please visit our website for the latest updates  
 If finishing items are needed, please refer to page 95-109 for further details

## Folder die-cutter

Series A Die-Cutter

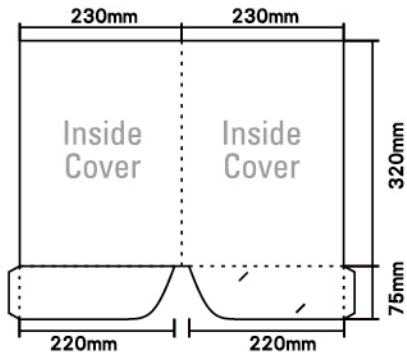

Finished Size: 230 x 320mm

Series B Die-Cutter

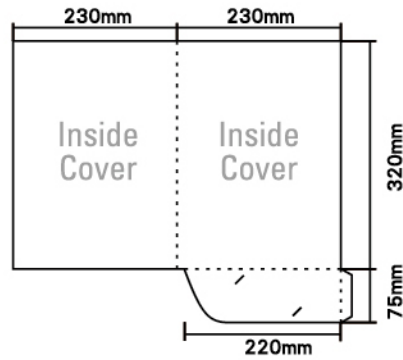

Finished Size: 230 x 320mm

Series E Die-Cutter

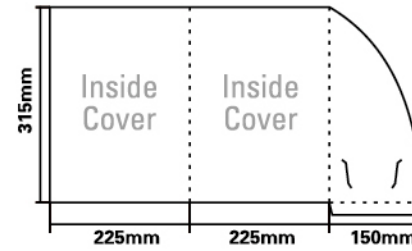

Finished Size: 225 x 315mm

Series F Die-Cutter

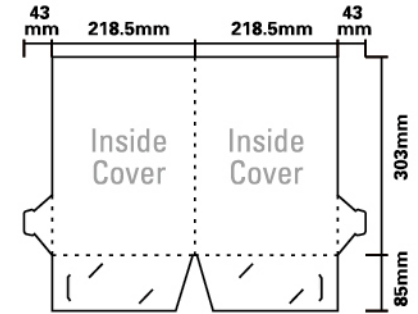

Finished Size: 218.5 x 303mm

Series C Die-Cutter

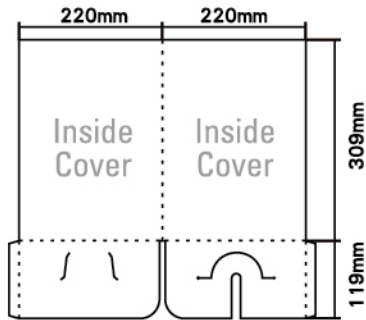

Finished Size: 220 x 309mm

Series D Die-Cutter

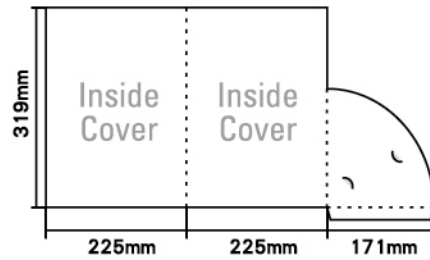

Finished Size: 225 x 319mm

Series G Die-Cutter

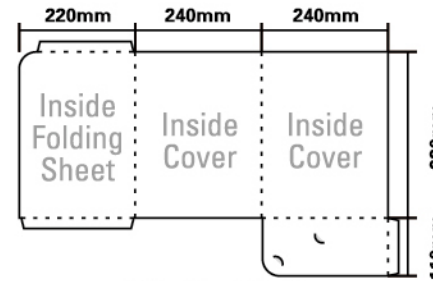

Finished Size: 240 x 320mm

Series H Die-Cutter

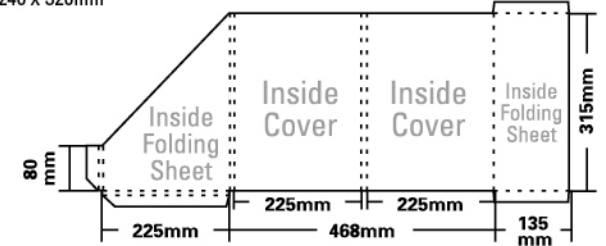

Finished Size: 225 x 315mm

# e-print Paper Bags

Size	Qty.	300 pcs	500 pcs	1,000 pcs	2,000 pcs	5,000 pcs	10,000 pcs
E-01 12(H) x 8.5 x 2.75"		\$6.50	\$4.50	\$3.50	\$3.00	\$2.40	\$2.20
E-02 10(H) x 8 x 3.25"		\$6.50	\$4.50	\$3.50	\$3.00	\$2.40	\$2.20
E-03 13(H) x 6.5 x 4"		\$6.50	\$4.50	\$3.50	\$3.00	\$2.40	\$2.20
E-04 12(H) x 10 x 4"		\$9.00	\$7.00	\$5.50	\$4.00	\$3.40	\$2.80
E-05 11(H) x 13 x 4"		\$9.00	\$7.00	\$5.50	\$4.00	\$3.40	\$2.80
E-06 16(H) x 13 x 4.25"		\$15.50	\$11.50	\$8.80	\$6.50	\$5.80	\$4.50
E-07 12(H) x 18 x 4.5"		\$14.00	\$11.50	\$8.80	\$6.50	\$5.80	\$4.50
E-08 17.25(H) x 24 x 5.5"		\$18.00	\$14.50	\$9.80	\$8.50	\$6.80	\$6.00

- Prices above are computed in unit price
- All paper bags are made by one side coated 210g White Back Board, with full-coloured printing and lamination
- For Embossing / Foil Stamping / Spot UV or Pantone colour, \$600 plate fee will be imposed on the total amount of price and an extra of \$0.3 will be charged for each bag within 10 square inches
- Prices above are based on 8 standard sizes, for other production request and quantity, please contact us for enquiry
- Own die-cutter will not be accepted; other special die-cutter production, please contact us for enquiry (Please provide die-cutter layout to produce)
- Over 50 types of handling rope / string for selection, please check the sample on website or branches
- The standard length of rope / string is 35-40cm (Cost already included in the above price), please remark if any special request
- Regarding the 8 standard sizes, please visit our website [www.e-print.com.hk](http://www.e-print.com.hk)

**Lead Time: 7 working days**

- \* Collecting from branches + 1 working day  
(Start from the date when customers confirm the proof)

Note: Please be aware that all the prices are subject to change without prior notice, please visit our website for the latest updates  
If finishing items are needed, please refer to page 95-109 for further details

# Kraft Paper Bags <sup>New</sup>

180g Brown Kraft Paper Bags /  
200g White Kraft Paper Bags

Size	Qty.	300 pcs	500 pcs	1,000 pcs	2,000 pcs	3,000 pcs	5,000 pcs	10,000 pcs
P-01 12(H) x 8.5 x 2.75"		\$5.50	\$4.50	\$3.50	\$2.50	\$2.50	\$2.00	\$2.00
P-02 10(H) x 8 x 3.25"		\$4.50	\$4.50	\$3.00	\$2.50	\$2.00	\$2.00	\$1.50
P-03 13(H) x 6.5 x 4"		\$4.50	\$4.50	\$3.00	\$2.50	\$2.00	\$2.00	\$1.50
P-04 12(H) x 10 x 4"		\$7.00	\$5.50	\$4.00	\$3.50	\$3.00	\$2.50	\$2.00
P-05 11(H) x 13 x 4"		\$7.00	\$5.50	\$4.00	\$3.50	\$3.00	\$3.00	\$2.00
P-06 16(H) x 13 x 4.25"		\$9.50	\$7.50	\$5.50	\$4.50	\$4.50	\$4.00	\$3.50
P-07 12(H) x 18 x 4.5"		\$9.50	\$7.50	\$5.50	\$4.50	\$4.50	\$4.00	\$3.50
P-08 17.25(H) x 24 x 5.5"		\$14.00	\$11.00	\$7.50	\$6.00	\$6.00	\$5.50	\$4.50

- Prices above are computed in unit price
- All kraft paper bags do not contain plastic materials
- Brown kraft paper bags and White kraft paper bags are made by 180g and 200g kraft paper respectively
- All kraft paper bags are printing by CMYK (4C + 0) or 15 types of designated spot color (Accept up to 2 colors)
- Prices above are based on 8 standard die-cutters, for other production request, non standard size and quantity, additional charges for die-cutter will be applied
- Own die-cutter will not be accepted; other special die-cutter production, please contact us for enquiry (Please provide die-cutter layout to produce)
- Up to 10 types of cotton rope, please visit our branches for more information
- Only SELECTED COTTON ROPES are available for kraft paper bags
- The standard length of ropes are 35-40cm (Cost included in the above price), please provide details if there are special requests
- All standard kraft paper bags die-cutters can be downloaded at "Download" in the company website
- Colors will demonstrate the differences based on different materials, please pay attention when placing an order

**Lead Time: 7 working days (below 4,000pcs)**

- 10 working days (4,000 - 10,000pcs)
- 10,000pcs above (contact us for enquiry)
- \* Collecting from branches + 1 working day  
(Start from the date when customers confirm the proof)

Note: Please be aware that all the prices are subject to change without prior notice, please visit our website for the latest updates

## Non-Woven Bags

Size	Qty.	100 pcs	300 pcs	500 pcs	1,000 pcs	2,000 pcs	5,000 pcs	10,000 pcs
N-01 12(H) x 8.5"		\$10.50	\$4.80	\$3.90	\$2.80	\$2.60	\$2.20	\$1.80
N-02 12(H) x 8.5 x 2.75"		\$11.00	\$5.30	\$4.30	\$3.30	\$2.90	\$2.50	\$2.00
N-03 12(H) x 12"		\$11.00	\$5.30	\$4.30	\$3.30	\$2.90	\$2.50	\$2.00
N-04 12(H) x 12 x 3"		\$12.00	\$5.90	\$4.70	\$3.70	\$3.30	\$2.80	\$2.20
N-05 12.75(H) x 16"		\$12.20	\$6.40	\$5.00	\$3.90	\$3.60	\$3.00	\$2.30
N-06 12.75(H) x 16 x 3.5"		\$12.70	\$7.00	\$5.20	\$4.00	\$3.70	\$3.20	\$2.60
N-07 16(H) x 16"		\$12.70	\$7.00	\$5.20	\$4.00	\$3.70	\$3.20	\$2.60
N-08 16(H) x 16 x 3.5"		\$13.20	\$7.50	\$5.40	\$4.20	\$3.80	\$3.30	\$2.70
N-09 20(H) x 16 x 4"		\$13.80	\$8.10	\$5.80	\$4.40	\$4.20	\$3.60	\$2.80
N-10 23(H) x 18 x 4.5"		\$14.30	\$8.60	\$6.10	\$4.90	\$4.50	\$3.90	\$3.00

- Prices above are computed in unit price
- Bags are made by 75g Non-Woven fabric, with single coloured printing on single side
- For each additional colour or printed side, an extra of \$300 plate fee will be imposed on the total amount of price and an extra of \$0.3 will be charged for each bag
- For using 100g Non-Woven fabric, an extra of \$0.3 will be charged for each bag
- Colour of handle ropes are consistency with the bag colour; if customer needs another ropes colour, please quote particularly and indicate clearly when ordering
- An extra of \$300 die-cutter fee will be charged for any Non-standard Die-Cutter

### Lead Time: 9 working days

- \* Collecting from branches + 1 working day  
(Except for items with finishing, start from the date when customers confirm the proof)  
(+ 1 working day will proceed for request of Non-Standard die-cutter)

Note: Please be aware that all the prices are subject to change without prior notice, please visit our website for the latest updates  
If finishing items are needed, please refer to page 95-109 for further details

## Pre-ink Stamps

(Available colours: Red, Purple Blue, Black)

Sample	Model	Size	Price
	C1	15mm	\$85
	C2	22mm	\$90
	C3	33mm	\$95
	C4	38mm	\$95
	OV	30 x 45mm	\$95
	Lacework Chop	24 x 53mm	\$95
	Cheque Chop	23 x 58mm	\$95
	Address Chop	22 x 60mm	\$95
	Goods Receipt Chop	38 x 51mm	\$95
	Signet Chop N1	12 x 12mm	\$85
	Signet Chop N2	15 x 15mm	\$90
	Signet Chop N3	22 x 22mm	\$95

- Please indicate the font size, type and format when ordering
- All pre-ink stamps are in standard format, artwork fee is included if customer provide the content
- For special design of stamp, customers are required to provide draft work
- Lines of Pre-ink Stamp is generally created with solid (100%) colour (Graphic and gradient color cannot be used)
- Pre-ink Stamp are normally made with solid colour
- Cut-Off Time:** Monday - Friday 4:30 pm and Saturday 11:30 am (Overdue will be deferred the next working day)

**Lead Time:** Red, Purple Blue Colour Pre-ink stamps: 1 working day

Black Colour Pre-ink stamps: 2 working days (Deliver on Tuesday, Wednesday and Saturday only)

\* Collecting from branches + 1 working day

(Except for items with finishing, start from the date when customers confirm the proof)

Note: Please be aware that all the prices are subject to change without prior notice, please visit our website for the latest updates

## Promotional Fan <sup>New</sup>

Type	Type A to E (300g Double-sided Coated Art Paper)	Type A to E (400g Double-sided Coated Art Paper)	Type A to E (0.6 mm PP Plastic Fan)	Type F (300g Double-sided Coated Art Paper)	Type G (300g Double-sided Coated Art Paper)
Size Qty.	Paper Fan 18 x 18cm	Paper Fan 18 x 18cm	Plastic Fan 18 x 18cm	Paper Fan 18 x 18cm	Paper Fan 20 x 20cm
1000	\$1,900	\$2,000	\$2,000	\$1,780	\$1,827
2000	\$2,850	\$3,000	\$3,400	\$2,068	\$2,120
3000	\$4,275	\$4,500	\$4,800	\$2,830	\$2,900
4000	\$4,940	\$5,200	\$6,000	\$3,296	\$3,375
5000	\$5,700	\$6,000	\$7,000	\$4,060	\$4,157
6000	\$6,270	\$6,600	\$8,160	\$4,324	\$4,424
7000	\$7,315	\$7,700	\$9,240	\$4,950	\$5,064
8000	\$8,360	\$8,800	\$10,240	\$5,453	\$5,577
9000	\$9,405	\$9,900	\$11,520	\$6,020	\$6,156
10000	\$9,975	\$10,500	\$12,500	\$6,431	\$6,575
20000	\$18,620	\$19,600	\$23,000	\$8,480	\$8,673
30000	\$27,930	\$29,400	\$33,000	\$12,090	\$12,361

- The price of fan handle has been included in Type A to E Promotion Fan price list
- Type F and Type G Promotional Fan has no fan handle
- The price of promotional fan include general geometry die-cutter; special die-cutters are negotiable
- Own die-cutter will not be accepted; other special die-cutter production, please contact us for enquiry (Please provide die-cutter layout to produce)
- The price of gloss lamination has been included in Promotional Fan price list
- Multiple fan handle colors are available, the length of handle is approximately 11cm
- For special die-cutter, customer should remind the position of handle hole and please download the instruction file of special die-cutters
- The price of gloss lamination has been included in Promotional Fan price list (Paper Fan Only)

**Lead Time:** Type A to E Promotional Fan: 1,000 to 10,000 pcs 5 working Days  
 Additional 10,000pcs + 1 working day  
 \* Collecting from branches + 1 working day  
 Type F to G Promotional Fan: 4 working days  
 \* Collecting from branches + 1 working day  
 (Start from the date when customers confirm the proof)  
 (Except for items with finishing, start from the date when customers confirm the proof)  
 \* + 1 day for Non- standard die-cutter, to be extended due to quantity

### Artwork Instruction

- Type A to G are available on our website
- Texts should be outlined, and resolution of graphic should be 300-350 dpi

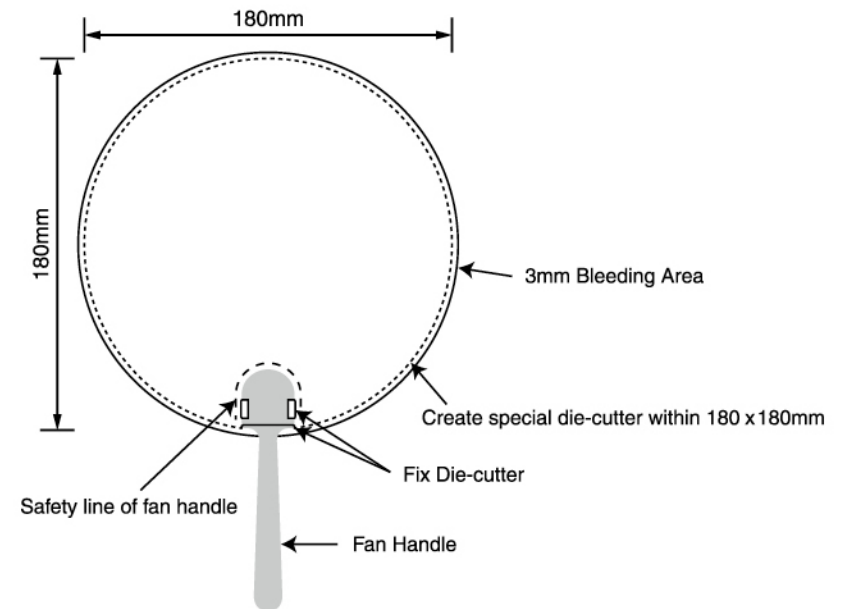

Note: Please be aware that all the prices are subject to change without prior notice, please visit our website for the latest updates  
 If finishing items are needed, please refer to page 95-109 for further details

## Hardcover Menu

If the UV printing area of cover exceed 100 x 100mm, here are charges:

Name	Style	Menu Size	Cover Printing Area	Inner Page Size
<b>Type A Cover</b>	Vertical	220 x 315 mm	198 x 307 mm	210 x 297 mm
<b>Type B Cover</b>	Horizontal	308 x 227 mm	283 x 219 mm	297 x 210 mm
<b>Type C Cover</b>	Square	240 x 228 mm	214 x 220 mm	230 x 210 mm
<b>Type D Cover</b>	Vertical	159 x 315 mm	135 x 307 mm	148 x 297 mm

Cover UV Printing Method	UV Area Within 100 x 200mm	UV Area Within 150 x 200mm	UV Area Within 200 x 200mm	UV Area Within 250 x 200mm	UV Area Within 300 x 200mm
<b>2D UV Printing</b>	Each pc +\$20	Each pc +\$40	Each pc +\$60	Each pc +\$80	Each pc +\$100
<b>3D UV Printing</b>	Each pc +\$30	Each pc +\$60	Each pc +\$90	Each pc +\$120	Each pc +\$150

- Hardcover Menu can ONLY be applied to the standard sizes as mentioned above; all standard Hardcover Menu's die-cutters can be downloaded at "Download" in the company website
- A little color difference between computer screen and finishing item if 3D UV printing of cover is adopted, customer should be reminded and it is not a rational basis for customer's reprint request under such circumstance
- UV Printing of Hardcover Menu is only applicable for Front Cover
- Each Hardcover Menu is packaging with plastic bag
- The maximum supported Ai version of manuscript is 5.0 and all texts should be converted to curves
- We do not support the manuscript when the background removal format of Photoshop insert into Ai File, customer need to draw the crop line in Ai instead

2D UV Printing Cover (100 x 100 mm)	Inner Page No.		3D UV Printing Cover (100 x 100 mm)	Inner Page No.	
	8PP	12PP		8PP	12PP
Quantity	8PP	12PP	Quantity	8PP	12PP
<b>1pc</b>	\$99	\$119	<b>1pc</b>	\$109	\$129
<b>5pc</b>	\$495	\$595	<b>5pc</b>	\$545	\$645
<b>10pc</b>	\$870	\$1,010	<b>10pc</b>	\$970	\$1,110
<b>20pc</b>	\$1,700	\$1,960	<b>20pc</b>	\$1,900	\$2,160
<b>30pc</b>	\$2,490	\$2,850	<b>30pc</b>	\$2,790	\$3,150
<b>40pc</b>	\$3,240	\$3,680	<b>40pc</b>	\$3,640	\$4,080
<b>50pc</b>	\$3,950	\$4,450	<b>50pc</b>	\$4,450	\$4,950
<b>100pc</b>	\$7,700	\$8,600	<b>100pc</b>	\$8,700	\$9,600

**Lead Time: 4 working days**

- \* Collecting from branches + 1 working day  
(Start from the date when customers confirm the proof)

- Cover of Hardcover Menu cover are Black, Brown, Pearl
- Prices above are calculated with High Class Plastic Imitation Leather and 250g Gloss Art Card
- Prices above are calculated with Inner Page's double-sided lamination (Gloss or Matt)
- For the manuscript, customer needs to reserve 18mm blank space from the left. Creasing line will be placed at that point in order to insert inner pages easily
- The cost of 100 x 100mm UV printing area of cover has been included in above price list

Note: Please be aware that all the prices are subject to change without prior notice, please visit our website for the latest updates

## Crystal Trophies

*Express Lead Time in Hong Kong!*

### Free Certificate

- Customer only needs to provide information for the certificate and e-print will attach a certificate for free (20 kinds of fancy paper and 5 formats available)
- 14 types of standard die-cutter draft artwork are available on our website [www.e-print.com.hk](http://www.e-print.com.hk)

**Lead Time:** 5 working days (Single coloured sand blasting)

7 working days (Coloured graphic)

\* Collecting from branches + 1 working day

(Start from the date when customers confirm the proof)

### Artwork Instruction

- Model A-N are available on our website
- Texts should be outlined, and resolution of graphic should be 300-350 dpi

Model	Size	Unit Price
A	Diameter 150mm	\$338
B	Diameter 150mm	\$338
C	110 x 55 x 190mm	\$338
D	150 x 35 x 165mm	\$338
E	100 x 35 x 160mm	\$338
F	90 x 30 x 180mm	\$338
G	105 x 45 x 180mm	\$338
H	100 x 45 x 200mm	\$338
I	100 x 45 x 200mm	\$358
J	160 x 10 x 150mm	\$358
K	Total Height 230mm	\$398
L	Total Height 260mm	\$448
M	Total Height 230mm	\$448
N	Total Height 180mm	\$468

- Prices above are calculated by production of sand blasting, additional \$80 will be imposed on each colour
- Additional \$120 will be imposed on full coloured production
- Sand blasting for the stand: +\$80

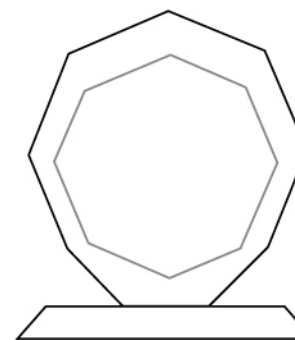
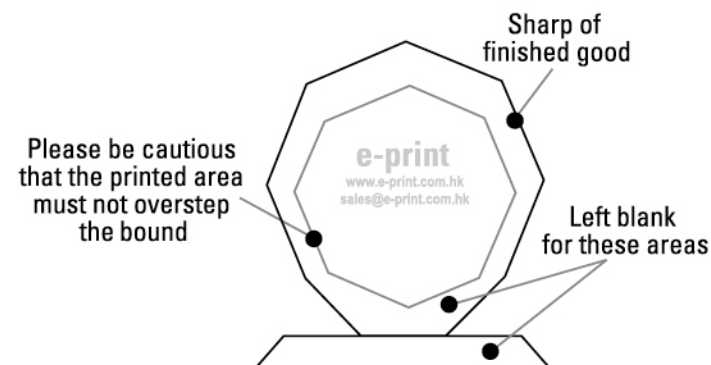

Finished Size: Diameter is 150mm

Note: Please be aware that all the prices are subject to change without prior notice, please visit our website for the latest updates

## Digital Printing Colour Leaflets

Qty.	A4 (4C + 4C)		A3 (4C + 4C)	
	Unit Price	Total Price	Unit Price	Total Price
5 pcs	\$8	\$40	\$15	\$75
10 pcs	\$7	\$70	\$9	\$90
20 pcs	\$6.5	\$130	\$8	\$160
30 pcs	\$6	\$180	\$7	\$210
40 pcs	\$5	\$200	\$6	\$240
50 pcs	\$4	\$200	\$5	\$250
100 pcs	\$3	\$300	\$4	\$400

- Prices above can be applied to the following paper materials: 80g Woodfree Paper, 100g Woodfree Paper, 140g Woodfree Paper, 128g Gloss Art Paper, 157g Gloss Art Paper, 128g Matt Art Paper, 157g Matt Art Paper, 210g Gloss Art Board, or 250g Gloss Art Board
- Font size and breadth of wordings from digital printing are thicker than wordings from off-set printing
- Printing quality of digital printing can meet the standard of off-set printing in most circumstances, for detail of the differences, please contact us for enquiry
- For White Paperboard and Woodfree Paper, colour in digital printing is generally sharper than colour in off-set printing
- The required instruction of preparing an artwork for digital printing is the same as off-set printing, please feel free to contact e-print for any enquiries

**Lead Time: 1 working day**  
(Start from the date when customers confirm the proof)

Note: Please be aware that all the prices are subject to change without prior notice, please visit our website for the latest updates  
If finishing items are needed, please refer to page 95-109 for further details

## Digital Fancy Cards

*Express Lead Time in Hong Kong!*

Model	Name	Weight	100 pcs	200 pcs	300 pcs	500 pcs	1,000 pcs
DP-19	The Digital	260g	\$58	\$98	\$138	\$218	\$418
DP-01	Smooth Veins	260g	\$68	\$118	\$168	\$268	\$518
DP-03	Smooth Spot	270g	\$68	\$118	\$168	\$268	\$518
DP-20	Eco Paper – Grey	216g	\$68	\$118	\$168	\$268	\$518
DP-21	Eco Paper – Beige	216g	\$68	\$118	\$168	\$268	\$518
DP-22	Exquisite	216g	\$68	\$118	\$168	\$268	\$518
DP-33	Glob Pattern	260g	\$68	\$118	\$168	\$268	\$518
DP-34	New Checker Graph	260g	\$68	\$118	\$168	\$268	\$518
DP-06	Aurora Pearl	250g	\$78	\$128	\$178	\$278	\$528
DP-07	Snow Pearl	250g	\$78	\$128	\$178	\$278	\$528
DP-23	Mingle – Off-White	192g	\$78	\$128	\$178	\$278	\$528
DP-24	Mingle – Beige	192g	\$78	\$128	\$178	\$278	\$528
DP-25	Mingle – White	192g	\$78	\$128	\$178	\$278	\$528
DP-26	Japanese Paper – Off-White	198g	\$78	\$128	\$178	\$278	\$528
DP-27	Japanese Paper – Beige	198g	\$78	\$128	\$178	\$278	\$528
DP-28	Earth Tone – Beige	209g	\$78	\$128	\$178	\$278	\$528
DP-29	Earth Tone – Off-White	209g	\$78	\$128	\$178	\$278	\$528
DP-30	Earth Tone – Pale Brown	209g	\$78	\$128	\$178	\$278	\$528
DP-36	Stripe Textured	216g	\$78	\$128	\$178	\$278	\$528
DP-31	Starry – White	209g	\$88	\$138	\$188	\$288	\$538
DP-32	Starry – Off-White	209g	\$88	\$138	\$188	\$288	\$538

- Prices above are calculated with standard size (90 x 54 mm), please indicate when ordering for non-standard size
- There is vertical and horizontal texture on fancy card paper and no specific orientation of texture is set. If customers have special request, please note when ordering, (Please note that under no circumstance should refund or reimbursement be accepted in terms of such issue)
- For every package of 100 pcs business card using co-publish printing method, its quantity may occur a variance of ±5% (Please note that under no circumstance should refund or reimbursement be accepted in terms of such issue)
- Delivery fee of business cards starts at \$15
- Embossing, Foil Stamping, Spot UV, Perforation and Die-Cutting are not recommended for digital fancy cards, as the difficulty to rectify position during the operational process
- For more details when drafting artwork for digital fancy card, please see "Product Catalog" for "Hints" and visit [www.e-print.com.hk](http://www.e-print.com.hk)

**Lead Time: 24 Hours**  
(Start from the date when customers confirm the proof)

Note: Please be aware that all the prices are subject to change without prior notice, please visit our website for the latest updates



## Digital Fancy Greeting Cards

*Four Price and Size Categories for Choice*

Model	Name	Weight	Size	50 pcs MOQ	100 pcs	300 pcs	500 pcs	1,000 pcs
DC-19	The Digital	260g	A6	\$88	\$148	\$358	\$488	\$878
			A5	\$148	\$258	\$628	\$848	\$1,528
			A4	\$238	\$428	\$1,038	\$1,408	\$2,528
			A3	\$388	\$688	\$1,668	\$2,258	\$4,068
DC-01	Smooth Veins	260g	A6	\$98	\$178	\$438	\$588	\$1,058
DC-03	Smooth Spot	270g						
DC-33	Glob Pattern	260g	A5	\$178	\$318	\$778	\$1,048	\$1,878
DC-20	Eco Paper – Grey	216g						
DC-21	Eco Paper – Beige	216g	A4	\$308	\$548	\$1,338	\$1,798	\$3,238
DC-22	Exquisite	216g						
DC-34	New Checker Graph	260g	A3	\$508	\$918	\$2,238	\$3,018	\$5,428
DC-23	Mingle – Off-White	192g						
DC-24	Mingle – Beige	192g	A6	\$118	\$208	\$508	\$688	\$1,228
DC-25	Mingle – White	192g						
DC-26	Japanese Paper – Off-White	198g						
DC-27	Japanese Paper – Beige	198g						
DC-28	Earth Tone – Beige	209g	A5	\$208	\$378	\$918	\$1,238	\$2,238
DC-29	Earth Tone – Off-White	209g						
DC-30	Earth Tone – Pale Brown	209g						
DC-36	Stripe Textured	216g	A4	\$368	\$658	\$1,598	\$2,158	\$3,888
<b>New</b> DC-37	Eco Linen – Whitestone	216g						
<b>New</b> DC-38	Linen – Rose Red	216g						
<b>New</b> DC-41	Sparkling Gold	250g	A3	\$628	\$1,118	\$2,718	\$3,668	\$6,608
<b>New</b> DC-43	Gorgeous Pink	210g						

Model	Name	Weight	Size	50 pcs MOQ	100 pcs	300 pcs	500 pcs	1,000 pcs
<b>New</b> DC-42	Gorgeous Yellow	308g						
<b>New</b> DC-44	Gorgeous Light Pink	308g	A6	\$138	\$248	\$608	\$818	\$1,468
DC-06	Aurora Pearl	250g						
DC-07	Snow Pearl	250g	A5	\$248	\$448	\$1,088	\$1,468	\$2,648
<b>New</b> DC-39	Neenah Classic Linen Pearl – Champagne Gold	227g						
<b>New</b> DC-40	Neenah Classic Linen Pearl – Silver Pearl	311g	A4	\$438	\$778	\$1,898	\$2,558	\$4,598
DC-31	Starry – White	209g						
DC-32	Starry – Off-White	209g	A3	\$738	\$1,328	\$3,228	\$4,358	\$7,848

- Prices above are assorted in four size categories. For custom, price is refer within the A3, A4 or A5 size categories
- Maximum size of this product is A3 (297 x 420mm); minimum size is A6 (105 x 148mm), size within A6 refers to "Digital Fancy Card" product
- The weight and quantity may occur a variance of  $\pm 5\%$
- Applicable Finishing Items: Perforation, Creasing, Round Cornering, Hole Drilling, die-cutting, Foil Stamping, Embossing (No effects of gradients, overprint and knockout in the finishing design)
- For providing a ideal output for consumer, please check and confirm the printed draft after ordering
- For more details of artwork, please refer to the note and tips of "Fancy Greeting Card product" on website

**Lead Time:** 1 working day

(Except for items with finishing, start from the date when customers confirm the proof)

Note: Please be aware that all the prices are subject to change without prior notice, please visit our website for the latest updates  
If finishing items are needed, please refer to page 95-109 for further details

Note: Please be aware that all the prices are subject to change without prior notice, please visit our website for the latest updates  
If finishing items are needed, please refer to page 95-109 for further details

## Digital Printing Colour Menus

### 250g Gloss Art Board

Qty.	A4 210 x 297mm		A3 297 x 420mm	
	Unit Price	Total Price	Unit Price	Total Price
5 pcs	\$10.00	\$50	\$19.00	\$95
10 pcs	\$9.00	\$90	\$13.00	\$130
20 pcs	\$8.50	\$170	\$12.00	\$240
30 pcs	\$8.00	\$240	\$11.00	\$330
40 pcs	\$7.00	\$280	\$10.00	\$400
50 pcs	\$6.00	\$300	\$9.00	\$450
100 pcs	\$5.00	\$500	\$8.00	\$800

- Prices above are calculated with 250g Gloss Art Board, including double-sided lamination and 3 creasing lines (Please indicate folding method when ordering)
- Font size and breadth of wordings from digital printing are thicker than wordings from off-set printing
- Printing quality of digital printing can meet the standard of off-set printing in most circumstances, for detail of the differences, please contact us for enquiry
- For using White Paperboard and Woodfree Paper, colour in digital printing is generally sharper than the colour in off-set printing
- The required instruction of preparing an artwork for digital printing is the same as off-set printing, please feel free to contact for any enquiries
- For more details, please refer to Digital Printing Coloured Saddle Stitching Booklet

**Lead Time: 1 working day**  
(Except for items with finishing, start from the date when customers confirm the proof)

Note: Please be aware that all the prices are subject to change without prior notice, please visit our website for the latest updates

## Digital Printing Colour Booklet Menus

### 250g Gloss Art Board

Page	A5 148 x 210mm				A4 210 x 297mm			
	8PP	12PP	16PP	20PP	8PP	12PP	16PP	20PP
Qty.	Unit Price	Unit Price	Unit Price	Unit Price	Unit Price	Unit Price	Unit Price	Unit Price
5 pcs	\$21	\$32	\$41	\$52	\$39	\$59	\$77	\$96
10 pcs	\$19	\$29	\$37	\$46	\$27	\$41	\$53	\$66
20 pcs	\$18	\$27	\$35	\$44	\$25	\$38	\$49	\$61
30 pcs	\$17	\$26	\$33	\$41	\$23	\$35	\$45	\$56
40 pcs	\$15	\$23	\$29	\$36	\$21	\$32	\$41	\$51
50 pcs	\$13	\$20	\$25	\$31	\$19	\$29	\$37	\$46
100pcs	\$11	\$17	\$21	\$26	\$17	\$26	\$33	\$41

- Prices above are calculated with 250g Gloss Art Board, including double-sided lamination
- Font size and breadth of wordings from digital printing are thicker than wordings from off-set printing
- Printing quality of digital printing can meet the standard of off-set printing in most circumstances, for detail of the differences, please contact us for enquiry
- For using White Paperboard and Woodfree Paper, colour in digital printing is generally sharper than the colour in off-set printing
- The required instruction of preparing an artwork for digital printing is the same as off-set printing, please feel free to contact for any enquiries
- For more details, please refer to Digital Printing Coloured Saddle Stitching Booklet

**Lead Time: 2 working days**  
(Except for items with finishing, start from the date when customers confirm the proof)

Note: Please be aware that all the prices are subject to change without prior notice, please visit our website for the latest updates  
If finishing items are needed, please refer to page 95-109 for further details

## Digital Printing Colour Saddle Stitching Booklets

A5 Full Colour Inner						
Page	Qty.	5 pcs	10 pcs	30 pcs	50 pcs	100 pcs
		Unit Price	Unit Price	Unit Price	Unit Price	Unit Price
8PP		\$13.20	\$10.00	\$8.40	\$7.60	\$6.80
12PP		\$19.60	\$14.80	\$12.40	\$11.20	\$10.00
16PP		\$26.00	\$19.60	\$16.40	\$14.80	\$13.20
20PP		\$32.40	\$24.40	\$20.40	\$18.40	\$16.40
24PP		\$38.80	\$29.20	\$24.40	\$22.00	\$19.60
28PP		\$45.20	\$34.00	\$28.40	\$25.60	\$22.80
32PP		\$51.60	\$38.80	\$32.40	\$29.20	\$26.00
36PP		\$58.00	\$43.60	\$36.40	\$32.80	\$29.20
40PP		\$64.40	\$48.40	\$40.40	\$36.40	\$32.40
44PP		\$70.80	\$53.20	\$44.40	\$40.00	\$35.60
48PP		\$77.20	\$58.00	\$48.40	\$43.60	\$38.80
52PP		\$83.60	\$62.80	\$52.40	\$47.20	\$42.00
56PP		\$90.00	\$67.60	\$56.40	\$50.80	\$45.20
60PP		\$96.40	\$72.40	\$60.40	\$54.40	\$48.40
64PP		\$102.80	\$77.20	\$64.40	\$58.00	\$51.60

A4 Full Colour Inner						
Page	Qty.	5 pcs	10 pcs	30 pcs	50 pcs	100 pcs
		Unit Price	Unit Price	Unit Price	Unit Price	Unit Price
8PP		\$16.50	\$12.50	\$10.50	\$9.50	\$8.50
12PP		\$24.50	\$18.50	\$15.50	\$14.00	\$12.50
16PP		\$32.50	\$24.50	\$20.50	\$18.50	\$16.50
20PP		\$40.50	\$30.50	\$25.50	\$23.00	\$20.50
24PP		\$48.50	\$36.50	\$30.50	\$27.50	\$24.50
28PP		\$56.50	\$42.50	\$35.50	\$32.00	\$28.50
32PP		\$64.50	\$48.50	\$40.50	\$36.50	\$32.50
36PP		\$72.50	\$54.50	\$45.50	\$41.00	\$36.50
40PP		\$80.50	\$60.50	\$50.50	\$45.50	\$40.50
44PP		\$88.50	\$66.50	\$55.50	\$50.00	\$44.50
48PP		\$96.50	\$72.50	\$60.50	\$54.50	\$48.50
52PP		\$104.50	\$78.50	\$65.50	\$59.00	\$52.50
56PP		\$112.50	\$84.50	\$70.50	\$63.50	\$56.50
60PP		\$120.50	\$90.50	\$75.50	\$68.00	\$60.50
64PP		\$128.50	\$96.50	\$80.50	\$72.50	\$64.50

- Prices above can be applied to 128g, 157g Gloss Art Paper / Matt Art Paper and 100g Woodfree Paper
- For using 250g Gloss Art Board for cover, additional \$4 will be imposed on each booklet
- If ordering quantity exceeds 100 pcs, total price will be calculated by ordering quantity x unit price (Based on 100 pcs)
- Font size and breadth of wordings from digital printing are thicker than wordings from off-set printing
- Printing quality of digital printing can meet the standard of off-set printing in most circumstances, for detail of the differences, please contact us for enquiry
- For using White Paperboard and Woodfree Paper, colour in digital printing is generally sharper than the colour in off-set printing
- The required instruction of preparing an artwork for digital printing is the same as off-set printing, please feel free to contact e-print for any enquiries
- Additional \$2 for Single sided lamination of cover; Additional \$4 for double sided lamination of cover (Gloss / Matt Lamination available)

- Prices above can be applied to 128g, 157g Gloss Art Paper / Matt Art Paper and 100g Woodfree Paper
- For using 250g Gloss Art Board for cover, additional \$4 will be imposed on each booklet
- If ordering quantity exceeds 100 pcs, total price will be calculated by ordering quantity x unit price (Based on 100 pcs)
- Font size and breadth of wordings from digital printing are thicker than wordings from off-set printing
- Printing quality of digital printing can meet the standard of off-set printing in most circumstances, for detail of the differences, please contact us for enquiry
- For using White Paperboard and Woodfree Paper, colour in digital printing is generally sharper than the colour in off-set printing
- The required instruction of preparing an artwork for digital printing is the same as off-set printing, please feel free to contact e-print for any enquiries
- Additional \$2 for Single sided lamination of cover; Additional \$4 for double sided lamination of cover (Gloss / Matt Lamination available)

**Lead Time: 2 working days (50 pcs or less)**  
(Start from the date when customers confirm the proof)

**Lead Time: 2 working days (50 pcs or less)**  
(Start from the date when customers confirm the proof)

Note: Please be aware that all the prices are subject to change without prior notice, please visit our website for the latest updates  
If finishing items are needed, please refer to page 95-109 for further details

Note: Please be aware that all the prices are subject to change without prior notice, please visit our website for the latest updates  
If finishing items are needed, please refer to page 95-109 for further details



A5 Single Colour Inner						
Page	Qty.	5 pcs	10 pcs	30 pcs	50 pcs	100 pcs
		Unit Price	Unit Price	Unit Price	Unit Price	Unit Price
8PP		\$10.00	\$8.40	\$6.80	\$6.00	\$5.20
12PP		\$14.80	\$12.40	\$10.00	\$8.80	\$7.60
16PP		\$19.60	\$16.40	\$13.20	\$11.60	\$10.00
20PP		\$24.40	\$20.40	\$16.40	\$14.40	\$12.40
24PP		\$29.20	\$24.40	\$19.60	\$17.20	\$14.80
28PP		\$34.00	\$28.40	\$22.80	\$20.00	\$17.20
32PP		\$38.80	\$32.40	\$26.00	\$22.80	\$19.60
36PP		\$43.60	\$36.40	\$29.20	\$25.60	\$22.00
40PP		\$48.40	\$40.40	\$32.40	\$28.40	\$24.40
44PP		\$53.20	\$44.40	\$35.60	\$31.20	\$26.80
48PP		\$58.00	\$48.40	\$38.80	\$34.00	\$29.20
52PP		\$62.80	\$52.40	\$42.00	\$36.80	\$31.60
56PP		\$67.60	\$56.40	\$45.20	\$39.60	\$34.00
60PP		\$72.40	\$60.40	\$48.40	\$42.40	\$36.40
64PP		\$77.20	\$64.40	\$51.60	\$45.20	\$38.80

- Prices above can be applied to 128g, 157g Gloss Art Paper / Matt Art Paper and 100g Woodfree Paper
- For using 250g Gloss Art Board for cover, additional \$4 will be imposed on each booklet; For colour printed cover, additional \$4 for each booklet
- If ordering quantity exceeds 100 pcs, total price will be calculated by ordering quantity x unit price (Based on 100 pcs)
- Font size and breadth of wordings from digital printing are thicker than wordings from off-set printing
- Printing quality of digital printing can meet the standard of off-set printing in most circumstances, for detail of the differences, please contact us for enquiry
- For using White Paperboard and Woodfree Paper, colour in digital printing is generally sharper than the colour in off-set printing
- The required instruction of preparing an artwork for digital printing is the same as off-set printing, please feel free to contact e-print for any enquiries
- Additional \$2 for Single sided lamination of cover; Additional \$4 for double sided lamination of cover (Gloss / Matt Lamination available)

**Lead Time: 2 working days (50 pcs or less)**  
(Start from the date when customers confirm the proof)

Note: Please be aware that all the prices are subject to change without prior notice, please visit our website for the latest updates  
If finishing items are needed, please refer to page 95-109 for further details

## Digital Printing Single Colour Saddle Stitching Booklets



A4 Single Colour Inner						
Page	Qty.	5 pcs	10 pcs	30 pcs	50 pcs	100 pcs
		Unit Price	Unit Price	Unit Price	Unit Price	Unit Price
8PP		\$12.50	\$10.50	\$8.50	\$7.50	\$6.50
12PP		\$18.50	\$15.50	\$12.50	\$11.00	\$9.50
16PP		\$24.50	\$20.50	\$16.50	\$14.50	\$12.50
20PP		\$30.50	\$25.50	\$20.50	\$18.00	\$15.50
24PP		\$36.50	\$30.50	\$24.50	\$21.50	\$18.50
28PP		\$42.50	\$35.50	\$28.50	\$25.00	\$21.50
32PP		\$48.50	\$40.50	\$32.50	\$28.50	\$24.50
36PP		\$54.50	\$45.50	\$36.50	\$32.00	\$27.50
40PP		\$60.50	\$50.50	\$40.50	\$35.50	\$30.50
44PP		\$66.50	\$55.50	\$44.50	\$39.00	\$33.50
48PP		\$72.50	\$60.50	\$48.50	\$42.50	\$36.50
52PP		\$78.50	\$65.50	\$52.50	\$46.00	\$39.50
56PP		\$84.50	\$70.50	\$56.50	\$49.50	\$42.50
60PP		\$90.50	\$75.50	\$60.50	\$53.00	\$45.50
64PP		\$96.50	\$80.50	\$64.50	\$56.50	\$48.50

- Prices above can be applied to 128g, 157g Gloss Art Paper / Matt Art Paper and 100g Woodfree Paper
- For using 250g Gloss Art Board for cover, additional \$4 will be imposed on each booklet; For colour printed cover, additional \$4 for each booklet
- If ordering quantity exceeds 100 pcs, total price will be calculated by ordering quantity x unit price (Based on 100 pcs)
- Font size and breadth of wordings from digital printing are thicker than wordings from off-set printing
- Printing quality of digital printing can meet the standard of off-set printing in most circumstances, for detail of the differences, please contact us for enquiry
- For using White Paperboard and Woodfree Paper, colour in digital printing is generally sharper than the colour in off-set printing
- The required instruction of preparing an artwork for digital printing is the same as off-set printing, please feel free to contact e-print for any enquiries
- Additional \$2 for Single sided lamination of cover; Additional \$4 for double sided lamination of cover (Gloss / Matt Lamination available)

**Lead Time: 2 working days (50 pcs or less)**  
(Start from the date when customers confirm the proof)

Note: Please be aware that all the prices are subject to change without prior notice, please visit our website for the latest updates  
If finishing items are needed, please refer to page 95-109 for further details

## Digital Printing Colour Perfect Binding Booklets

A5 Full Colour Inner						
Page	Qty.	5 pcs	10 pcs	30 pcs	50 pcs	100 pcs
		Unit Price	Unit Price	Unit Price	Unit Price	Unit Price
68PP		\$115.20	\$88.00	\$74.40	\$67.60	\$60.80
72PP		\$121.60	\$92.80	\$78.40	\$71.20	\$64.00
76PP		\$128.00	\$97.60	\$82.40	\$74.80	\$67.20
80PP		\$134.40	\$102.40	\$86.40	\$78.40	\$70.40
84PP		\$140.80	\$107.20	\$90.40	\$82.00	\$73.60
88PP		\$147.20	\$112.00	\$94.40	\$85.60	\$76.80
92PP		\$153.60	\$116.80	\$98.40	\$89.20	\$80.00
96PP		\$160.00	\$121.60	\$102.40	\$92.80	\$83.20
100PP		\$166.40	\$126.40	\$106.40	\$96.40	\$86.40
104PP		\$172.80	\$131.20	\$110.40	\$100.00	\$89.60
108PP		\$179.20	\$136.00	\$114.40	\$103.60	\$92.80
112PP		\$185.60	\$140.80	\$118.40	\$107.20	\$96.00
116PP		\$192.00	\$145.60	\$122.40	\$110.80	\$99.20
120PP		\$198.40	\$150.40	\$126.40	\$114.40	\$102.40
124PP		\$204.80	\$155.20	\$130.40	\$118.00	\$105.60
128PP		\$211.20	\$160.00	\$134.40	\$121.60	\$108.80

A4 Full Colour Inner						
Page	Qty.	5 pcs	10 pcs	30 pcs	50 pcs	100 pcs
		Unit Price	Unit Price	Unit Price	Unit Price	Unit Price
68PP		\$144.00	\$110.00	\$93.00	\$84.50	\$76.00
72PP		\$152.00	\$116.00	\$98.00	\$89.00	\$80.00
76PP		\$160.00	\$122.00	\$103.00	\$93.50	\$84.00
80PP		\$168.00	\$128.00	\$108.00	\$98.00	\$88.00
84PP		\$176.00	\$134.00	\$113.00	\$102.50	\$92.00
88PP		\$184.00	\$140.00	\$118.00	\$107.00	\$96.00
92PP		\$192.00	\$146.00	\$123.00	\$111.50	\$100.00
96PP		\$200.00	\$152.00	\$128.00	\$116.00	\$104.00
100PP		\$208.00	\$158.00	\$133.00	\$120.50	\$108.00
104PP		\$216.00	\$164.00	\$138.00	\$125.00	\$112.00
108PP		\$224.00	\$170.00	\$143.00	\$129.50	\$116.00
112PP		\$232.00	\$176.00	\$148.00	\$134.00	\$120.00
116PP		\$240.00	\$182.00	\$153.00	\$138.50	\$124.00
120PP		\$248.00	\$188.00	\$158.00	\$143.00	\$128.00
124PP		\$256.00	\$194.00	\$163.00	\$147.50	\$132.00
128PP		\$264.00	\$200.00	\$168.00	\$152.00	\$136.00

- Prices above can be applied to 128g, 157g Gloss Art Paper / Matt Art Paper and 100g Woodfree Paper
- For using 250g Gloss Art Board for cover, additional \$4 will be imposed on each booklet
- If ordering quantity exceeds 100 pcs, total price will be calculated by ordering quantity x unit price (Based on 100 pcs)
- Font size and breadth of wordings from digital printing are thicker than wordings from off-set printing
- Printing quality of digital printing can meet the standard of off-set printing in most circumstances, for detail of the differences, please contact us for enquiry
- For using White Paperboard and Woodfree Paper, colour in digital printing is generally sharper than the colour in off-set printing
- The required instruction of preparing an artwork for digital printing is the same as off-set printing, please feel free to contact e-print for any enquiries
- Additional \$2 for Single sided lamination of cover; Additional \$4 for double sided lamination of cover (Gloss / Matt Lamination available)

- Prices above can be applied to 128g, 157g Gloss Art Paper / Matt Art Paper and 100g Woodfree Paper
- For using 250g Gloss Art Board for cover, additional \$4 will be imposed on each booklet
- If ordering quantity exceeds 100 pcs, total price will be calculated by ordering quantity x unit price (Based on 100 pcs)
- Font size and breadth of wordings from digital printing are thicker than wordings from off-set printing
- Printing quality of digital printing can meet the standard of off-set printing in most circumstances, for detail of the differences, please contact us for enquiry
- For using White Paperboard and Woodfree Paper, colour in digital printing is generally sharper than the colour in off-set printing
- The required instruction of preparing an artwork for digital printing is the same as off-set printing, please feel free to contact e-print for any enquiries
- Additional \$2 for Single sided lamination of cover; Additional \$4 for double sided lamination of cover (Gloss / Matt Lamination available)

**Lead Time: 2 working days (50 pcs or less)**  
(Start from the date when customers confirm the proof)

**Lead Time: 2 working days (50 pcs or less)**  
(Start from the date when customers confirm the proof)

Note: Please be aware that all the prices are subject to change without prior notice, please visit our website for the latest updates  
If finishing items are needed, please refer to page 95-109 for further details

Note: Please be aware that all the prices are subject to change without prior notice, please visit our website for the latest updates  
If finishing items are needed, please refer to page 95-109 for further details



A5 Single Colour Inner						
Page	Qty.	5 pcs	10 pcs	30 pcs	50 pcs	100 pcs
		Unit Price	Unit Price	Unit Price	Unit Price	Unit Price
68PP		\$88.00	\$74.40	\$60.80	\$54.00	\$47.20
72PP		\$92.80	\$78.40	\$64.00	\$56.80	\$49.60
76PP		\$97.60	\$82.40	\$67.20	\$59.60	\$52.00
80PP		\$102.40	\$86.40	\$70.40	\$62.40	\$54.40
84PP		\$107.20	\$90.40	\$73.60	\$65.20	\$56.80
88PP		\$112.00	\$94.40	\$76.80	\$68.00	\$59.20
92PP		\$116.80	\$98.40	\$80.00	\$70.80	\$61.60
96PP		\$121.60	\$102.40	\$83.20	\$73.60	\$64.00
100PP		\$126.40	\$106.40	\$86.40	\$76.40	\$66.40
104PP		\$131.20	\$110.40	\$89.60	\$79.20	\$68.80
108PP		\$136.00	\$114.40	\$92.80	\$82.00	\$71.20
112PP		\$140.80	\$118.40	\$96.00	\$84.80	\$73.60
116PP		\$145.60	\$122.40	\$99.20	\$87.60	\$76.00
120PP		\$150.40	\$126.40	\$102.40	\$90.40	\$78.40
124PP		\$155.20	\$130.40	\$105.60	\$93.20	\$80.80
128PP		\$160.00	\$134.40	\$108.80	\$96.00	\$83.20

- Prices above can be applied to 128g, 157g Gloss Art Paper / Matt Art Paper and 100g Woodfree Paper
- For using 250g Gloss Art Board for cover, additional \$4 will be imposed on each booklet; For colour printed cover, additional \$4 for each booklet
- If ordering quantity exceeds 100 pcs, total price will be calculated by ordering quantity x unit price (Based on 100 pcs)
- Font size and breadth of wordings from digital printing are thicker than wordings from off-set printing
- Printing quality of digital printing can meet the standard of off-set printing in most circumstances, for detail of the differences, please contact us for enquiry
- For using White Paperboard and Woodfree Paper, colour in digital printing is generally sharper than the colour in off-set printing
- The required instruction of preparing an artwork for digital printing is the same as off-set printing, please feel free to contact e-print for any enquiries
- Additional \$2 for Single sided lamination of cover; Additional \$4 for double sided lamination of cover (Gloss / Matt Lamination available)

**Lead Time:** 2 working days (50 pcs or less; start from the date when customers confirm the proof)

Note: Please be aware that all the prices are subject to change without prior notice, please visit our website for the latest updates  
If finishing items are needed, please refer to page 95-109 for further details

## Digital Printing Single Colour Perfect Binding Booklets



A4 Single Colour Inner						
Page	Qty.	5 pcs	10 pcs	30 pcs	50 pcs	100 pcs
		Unit Price	Unit Price	Unit Price	Unit Price	Unit Price
68PP		\$110.00	\$93.00	\$76.00	\$67.50	\$59.00
72PP		\$116.00	\$98.00	\$80.00	\$71.00	\$62.00
76PP		\$122.00	\$103.00	\$84.00	\$74.50	\$65.00
80PP		\$128.00	\$108.00	\$88.00	\$78.00	\$68.00
84PP		\$134.00	\$113.00	\$92.00	\$81.50	\$71.00
88PP		\$140.00	\$118.00	\$96.00	\$85.00	\$74.00
92PP		\$146.00	\$123.00	\$100.00	\$88.50	\$77.00
96PP		\$152.00	\$128.00	\$104.00	\$92.00	\$80.00
100PP		\$158.00	\$133.00	\$108.00	\$95.50	\$83.00
104PP		\$164.00	\$138.00	\$112.00	\$99.00	\$86.00
108PP		\$170.00	\$143.00	\$116.00	\$102.50	\$89.00
112PP		\$176.00	\$148.00	\$120.00	\$106.00	\$92.00
116PP		\$182.00	\$153.00	\$124.00	\$109.50	\$95.00
120PP		\$188.00	\$158.00	\$128.00	\$113.00	\$98.00
124PP		\$194.00	\$163.00	\$132.00	\$116.50	\$101.00
128PP		\$200.00	\$168.00	\$136.00	\$120.00	\$104.00

- Prices above can be applied to 128g, 157g Gloss Art Paper / Matt Art Paper and 100g Woodfree Paper
- For using 250g Gloss Art Board for cover, additional \$4 will be imposed on each booklet; For colour printed cover, additional \$4 for each booklet
- If ordering quantity exceeds 100 pcs, total price will be calculated by ordering quantity x unit price (Based on 100 pcs)
- Font size and breadth of wordings from digital printing are thicker than wordings from off-set printing
- Printing quality of digital printing can meet the standard of off-set printing in most circumstances, for detail of the differences, please contact us for enquiry
- For using White Paperboard and Woodfree Paper, colour in digital printing is generally sharper than the colour in off-set printing
- The required instruction of preparing an artwork for digital printing is the same as off-set printing, please feel free to contact e-print for any enquiries
- Additional \$2 for Single sided lamination of cover; Additional \$4 for double sided lamination of cover (Gloss / Matt Lamination available)

**Lead Time:** 2 working days (50 pcs or less; start from the date when customers confirm the proof)

Note: Please be aware that all the prices are subject to change without prior notice, please visit our website for the latest updates  
If finishing items are needed, please refer to page 95-109 for further details

## Digital Printing Notebooks

A4		
Type Qty.	Full Color Cover (Single Color Inner)	Full Color Cover + UV (Single Color Inner)
5 pcs	\$180	\$275
10 pcs	\$335	\$435
15 pcs	\$490	\$590
20 pcs	\$650	\$755
25 pcs	\$805	\$910
30 pcs	\$960	\$1,070
35 pcs	\$1,115	\$1,225
40 pcs	\$1,270	\$1,385
45 pcs	\$1,425	\$1,540
50 pcs	\$1,595	\$1,715
100 pcs	\$3,240	\$3,390
200 pcs	\$3,950	\$4,215

A5		
Type Qty.	Full Color Cover (Single Color Inner)	Full Color Cover + UV (Single Color Inner)
5 pcs	\$120	\$215
10 pcs	\$220	\$315
15 pcs	\$315	\$410
20 pcs	\$415	\$515
25 pcs	\$510	\$610
30 pcs	\$605	\$705
35 pcs	\$705	\$805
40 pcs	\$800	\$905
45 pcs	\$900	\$1,005
50 pcs	\$1,005	\$1,110
100 pcs	\$2,050	\$2,170
200 pcs	\$2,580	\$4,020

A6		
Type Qty.	Full Color Cover (Single Color Inner)	Full Color Cover + UV (Single Color Inner)
5 pcs	—	—
10 pcs	\$175	\$270
15 pcs	\$250	\$345
20 pcs	\$325	\$420
25 pcs	\$400	\$495
30 pcs	\$475	\$570
35 pcs	\$550	\$645
40 pcs	\$625	\$725
45 pcs	\$700	\$800
50 pcs	\$785	\$885
100 pcs	\$1,610	\$1,715
200 pcs	\$2,950	\$3,070

- The cover of the Notebook could be in double-sided printed in full colour or black & white
- The cover of Notebook must use 310g Gloss double-sided coated cardboard, double-sided color printing and single-sided Matt Cover
- The inside pages of Notebook must use 80 Sheets (160pp), 80g paper, unified design for inside pages
- The spine of Notebook must be in 14mm
- The double wire-o of Notebook used are black in colour
- Notebook can ONLY be applied to the standard sizes as mentioned above; all standard Notebook die-cutters can be downloaded at "Download" in the company website [www.e-print.com.hk](http://www.e-print.com.hk) (Not available for other sizes)
- Finishing items could be applied to Notebook, additional charges for finishing items
- Please visit our branches for more product information

**Lead Time: 7 working days**

\* Collecting from branches + 1 working day  
(Start from the date when customers confirm the proof)

Note: Please be aware that all the prices are subject to change without prior notice, please visit our website for the latest updates  
If finishing items are needed, please refer to page 95-109 for further details

## Seamless Photobook

Seamless Photobook					
	Size	Paper	Pages	Lead Time	Price
<b>Grace</b>	205(W) x 145(H) mm	<b>Cover:</b> Matt Lamination Hardback Gloss Art Board <b>Inner:</b> 200g Gloss Art Board	30PP	7 Days	\$118
	205(W) x 200(H) mm				\$158
<b>Luxury</b>	205(W) x 145(H) mm	<b>Cover:</b> Matt Lamination Hardback Gloss Art Board <b>Inner:</b> 200g Gloss Art Board + Gloss Lamination			\$138
	205(W) x 200(H) mm				\$188
	210(W) x 285(H) mm (A4 Size)	<b>Cover:</b> Gloss Lamination Hardback Gloss Art Board <b>Inner:</b> 260g Gloss Art Board + Water Base Varnishing			\$220
<b>Honour</b>	210(W) x 148(H) mm	<b>Cover:</b> Matt Lamination Hardback Gloss Art Board <b>Inner:</b> Gloss Photographic paper			\$228
	210(W) x 210(H) mm		\$328		

Seamy Photobook					
	Size	Paper	Pages	Lead Time	Price
<b>Grace</b>	205(W) x 145(H) mm	<b>Cover:</b> Matt Lamination Hardback Gloss Art Board <b>Inner:</b> 200g Gloss Art Board	32PP (Available for extra pages) Maximum 72PP	5 Days	\$88
	205(W) x 200(H) mm				\$128
<b>Luxury</b>	205(W) x 145 (H) mm	<b>Cover:</b> Matt Lamination Hardback Gloss Art Board <b>Inner:</b> 200g Gloss Art Board + Gloss Lamination			\$98
	205(W) x 200(H) mm				\$138
	210(W) x 285(H) mm (A4 Size)	<b>Cover:</b> Gloss Lamination Hardback Gloss Art Board <b>Inner:</b> One Side Coated White Back Board + Rubbed Finish			\$170

## Wire Ring Binding Photobook

Wire Ring Binding Photobook					
	Size	Paper	Pages	Lead Time	Price
<b>Grace</b>	205(W) x 145(H) mm	<b>Cover:</b> Matt Lamination Gloss Art Board <b>Inner:</b> 200g Gloss Art Board	32PP (Available for extra pages) Maximum 80PP	5 Days	\$68
	205(W) x 200(H) mm				\$98
<b>Fantasy</b>	205(W) x 145 (H) mm	<b>Cover:</b> Gloss Art Board + Sand Blasting Film <b>Inner:</b> 200g Gloss Art Board			\$68
	205(W) x 200(H) mm				\$98

\* Collecting from branches + 2 working day

## Mini-Photobook (with mobile phone strap)

Mini-Photobook (with mobile phone strap)					
	Size	Paper	Pages	Lead Time	Price
	28(W) x 38(H) mm	<b>Cover:</b> 24 Types Available <b>Inner:</b> Gloss Art Photographic Paper	18PP	2 Days	\$39

\* Collecting from branches + 2 working day





### Calendar

Desk Calendar				
Size	Paper	Pages	Lead Time	Price
145(W) x 115(H) mm	<b>Cover / Inner:</b> 260g White Woodfree Paper with Rain Drops Pattern	26PP	5 Days	\$38
210(W) x 145(H) mm				\$48
245(W) x 145(H) mm				\$58

Wall Calendar				
Size	Paper	Pages	Lead Time	Price
90(W) x 90(H) mm	<b>Cover:</b> Fancy Paper <b>Inner:</b> 200g Gloss Art Board	26PP	5 Days	\$38 / 2 pcs
290(W) x 210(H) mm				\$58

Weekly Calendar				
Size	Paper	Pages	Lead Time	Price
325(W) x 115(H) mm	<b>Cover:</b> 300g Gloss Art Board with Double-Sided Coated <b>Inner:</b> 80g Woodfree Paper	56PP	5 Days	\$68

\* Collecting from branches + 2 working day

## Finishing Items

### Lamination

Size	Qty. Type	500	1,000	2,000	3,000	4,000	5,000
		<b>A3 420 x 297mm (16.5 x 11.69")</b>					
	1 Side Gloss	\$200	\$200	\$328	\$492	\$656	\$820
	2 Sides Gloss	\$200	\$328	\$656	\$984	\$1,313	\$1,641
	1 Side Matt	\$400	\$400	\$525	\$788	\$1,050	\$1,313
	2 Sides Matt	\$400	\$525	\$1,050	\$1,575	\$2,100	\$2,625
<b>594 x 420mm (24 x 17")</b>							
	1 Side Gloss	\$200	\$306	\$612	\$918	\$1,224	\$1,530
	2 Sides Gloss	\$306	\$612	\$1,224	\$1,836	\$2,448	\$3,060
	1 Side Matt	\$400	\$490	\$979	\$1,469	\$1,958	\$2,448
	2 Sides Matt	\$490	\$979	\$1,958	\$2,938	\$3,917	\$4,896
<b>863 x 594mm (34 x 24")</b>							
	1 Side Gloss	\$328	\$656	\$1,313	\$1,969	\$2,625	\$3,281
	2 Sides Gloss	\$656	\$1,313	\$2,625	\$3,938	\$5,250	\$6,563
	1 Side Matt	\$529	\$1,059	\$2,118	\$3,176	\$4,235	\$5,294
	2 Sides Matt	\$1,050	\$2,100	\$4,200	\$6,300	\$8,400	\$10,500

· Minimum charge for Gloss Lamination: \$200

· Minimum charge for Matt Lamination: \$400

**Lead Time:** + 1 working day (Depends on quantity)

Note: Please be aware that all the prices are subject to change without prior notice, please visit our website for the latest updates

## Finishing Items

### Folding – A1

Style	Available Size	Completed Size	First 1,000 pcs	Additional for every 1,000 pcs
Half-Fold	A1 840 x 594mm	L594 x W420	\$80	+\$35
Crossfold		L420 x W297	\$110	+\$35
Letter Fold 6PP Accordion Fold		L594 x W280	\$110	+\$35
8PP Roll Fold 8PP Accordion Fold		L594 x W210	\$150	+\$35
10PP Roll Fold 10PP Accordion Fold		L594 x W168	\$180	+\$35
12PP Accordion Fold		L594 x W140	\$210	+\$35
14PP Accordion Fold		L594 x W120	\$240	+\$35
Crossfold With 3 Edges Trimmed		L420 x W297	\$110	+\$35
Gatefold		L594 x W420	\$110	+\$35
Double Parallel-Fold		L594 x W210	\$150	+\$35
Letter Fold + Half-Fold 6PP Accordion Fold + Half-Fold		L297 x W280	\$150	+\$35
8PP Roll Fold + Half-Fold 8PP Accordion Fold + Half-Fold		L297 x W210	\$180	+\$35

Folding services above are limited to paper material (80-157g paper)

Note: Please be aware that all the prices are subject to change without prior notice, please visit our website for the latest updates

## Finishing Items

### Folding – A1 New

Style	Available Size	Completed Size	First 1,000 pcs	Additional for every 1,000 pcs
Half-Fold + 8PP Accordion Fold (H)	A1 840 x 594mm	L420 x W148	\$240	+\$35
Half-Fold + 10PP Accordion Fold (H)		L420 x W118	\$240	+\$35
Letter Fold + 8PP Accordion Fold (H)		L280 x W148	\$280	+\$35
Letter Fold + 10PP Accordion Fold (H)		L280 x W118	\$280	+\$35
8PP Roll Fold + 8PP Accordion Fold (H)		L210 x W148	\$320	+\$35
8PP Roll Fold + 10PP Accordion Fold (H)		L210 x W118	\$320	+\$35
6PP Accordion Fold + 8PP Accordion Fold (H)		L280 x W148	\$280	+\$35
8PP Accordion Fold + 8PP Accordion Fold (H)		L210 x W148	\$280	+\$35
10PP Accordion Fold + 8PP Accordion Fold (H)		L168 x W148	\$360	+\$35
6PP Accordion Fold + 10PP Accordion Fold (H)		L280 x W118	\$360	+\$35
8PP Accordion Fold + 10PP Accordion Fold (H)		L210 x W118	\$360	+\$35
Special Half-Fold + 8PP Accordion Fold		L594 x W140	\$240	+\$35
Special Half-Fold + 10PP Accordion Fold		L594 x W120	\$280	+\$35
16PP Accordion Fold		L594 x W105	\$280	+\$35
18PP Accordion Fold		L594 x W93	\$320	+\$35
20PP Accordion Fold		L594 x W84	\$320	+\$35
12PP Roll Fold		L594 x W140	\$240	+\$35
Letter Fold + Crossfold Accordion Fold + Crossfold		L297 x W140	\$360	+\$35

Folding services above are limited to paper material (80-128g paper)

Note: Please be aware that all the prices are subject to change without prior notice, please visit our website for the latest updates

## Finishing Items

### Folding – A2

Style	Available Size	Completed Size	First 1,000 pcs	Additional for every 1,000 pcs
Half-Fold	A2 594 x 420mm	L420 x W297	\$80	+\$35
Crossfold		L297 x W210	\$110	+\$35
Letter Fold 6PP Accordion Fold		L420 x W198	\$110	+\$35
8PP Roll Fold 8PP Accordion Fold		L420 x W148	\$150	+\$35
10PP Roll Fold 10PP Accordion Fold		L420 x W118	\$180	+\$35
12PP Accordion Fold		L420 x W99	\$210	+\$35
14PP Accordion Fold		L420 x W84	\$240	+\$35
Crossfold With 3 Edges Trimmed		L297 x W210	\$110	+\$35
Double Gatefold		L420 x W148	\$150	+\$35
Gatefold		L420 x W297	\$110	+\$35
Double Parallel-Fold		L420 x W148	\$150	+\$35
Letter Fold + Half-Fold 6PP Accordion Fold + Half-Fold		L210 x W198	\$150	+\$35
8PP Roll Fold + Half-Fold 8PP Accordion Fold + Half-Fold		L210 x W148	\$180	+\$35
Half-Fold + Letter Fold Half-Fold + 6PP Accordion Fold		L297 x W140	\$150	+\$35
Half-Fold + 8PP Accordion Fold		L297 x W105	\$180	+\$35

Folding services above are limited to paper material (80-157g paper)

Note: Please be aware that all the prices are subject to change without prior notice, please visit our website for the latest updates

## Finishing Items

### Folding – A2 New

Style	Available Size	Completed Size	First 1,000 pcs	Additional for every 1,000 pcs
Half-Fold + 8PP Accordion Fold (H)	A2 594 x 420mm	L297 x W105	\$240	+\$35
Half-Fold + 10PP Accordion Fold (H)		L297 x W84	\$240	+\$35
Letter Fold + 8PP Accordion Fold (H)		L198 x W105	\$280	+\$35
Letter Fold + 10PP Accordion Fold (H)		L198 x W84	\$280	+\$35
8PP Roll Fold + 8PP Accordion Fold (H)		L148 x W105	\$320	+\$35
8PP Roll Fold + 10PP Accordion Fold (H)		L148 x W84	\$320	+\$35
6PP Accordion Fold + 8PP Accordion Fold (H)		L198 x W105	\$280	+\$35
8PP Accordion Fold + 8PP Accordion Fold (H)		L148 x W105	\$280	+\$35
10PP Accordion Fold + 8PP Accordion Fold (H)		L118 x W105	\$360	+\$35
6PP Accordion Fold + 10PP Accordion Fold (H)		L198 x W84	\$360	+\$35
8PP Accordion Fold + 10PP Accordion Fold (H)		L148 x W84	\$360	+\$35
Special Half-Fold + 8PP Accordion Fold		L420 x W99	\$240	+\$35
Special Half-Fold + 10PP Accordion Fold		L420 x W84	\$280	+\$35
16PP Accordion Fold		L420 x W74	\$280	+\$35
18PP Accordion Fold		L420 x W66	\$320	+\$35
20PP Accordion Fold		L420 x W59	\$320	+\$35
12PP Roll Fold	L420 x W99	\$240	+\$35	
Letter Fold + Crossfold Accordion Fold + Crossfold	L210 x W99	\$360	+\$35	

Folding services above are limited to paper material (80-128g paper)

Note: Please be aware that all the prices are subject to change without prior notice, please visit our website for the latest updates

## Finishing Items

### Folding – A3

Style	Available Size	Completed Size	First 1,000 pcs	Additional for every 1,000 pcs
Half-Fold	A3 420 x 297mm	L210 x 297 W148 x 420	\$50	+\$25
Letter Fold 6PP Accordion Fold		L140 x 297 W99 x 420	\$70	+\$25
8PP Roll Fold 8PP Accordion Fold		L105 x 297 W74 x 420	\$90	+\$25
Gatefold		L210 x 297	\$70	+\$25
Double Gatefold		L105 x 297	\$90	+\$25
Double Parallel-Fold		L105 x 297	\$90	+\$25
Crossfold		210 x 148	\$70	+\$25
10PP Accordion Fold		L84 x 297	\$110	+\$25
12PP Accordion Fold		L70 x 297	\$140	+\$25
14PP Accordion Fold		L60 x 297	\$160	+\$25
Letter Fold + Half-Fold 6PP Accordion Fold + Half-Fold		140 x 148	\$90	+\$25
8PP Roll Fold + Half-Fold 8PP Accordion Fold + Half-Fold		105 x 148	\$110	+\$25
Half-Fold + Letter Fold Half-Fold + 6PP Accordion Fold		210 x 99	\$90	+\$25
Half-Fold + 8PP Accordion Fold		210 x 74	\$110	+\$25
Crossfold With 3 Edges Trimmed		L210 x 148	\$110	+\$35

Folding services above are limited to paper material (80-157g paper)

Note: Please be aware that all the prices are subject to change without prior notice, please visit our website for the latest updates

## Finishing Items

### Folding – A3 New

Style	Available Size	Completed Size	First 1,000 pcs	Additional for every 1,000 pcs
Half-Fold + 8PP Accordion Fold (H)	A3 420 x 297mm	L210 x W74	\$240	+\$35
Half-Fold + 10PP Accordion Fold (H)		L210 x W59	\$240	+\$35
Letter Fold + 8PP Accordion Fold (H)		L140 x W74	\$280	+\$35
Letter Fold + 10PP Accordion Fold (H)		L140 x W59	\$280	+\$35
8PP Roll Fold + 8PP Accordion Fold (H)		L105 x W74	\$320	+\$35
8PP Roll Fold + 10PP Accordion Fold (H)		L105 x W59	\$320	+\$35
6PP Accordion Fold + 8PP Accordion Fold (H)		L140 x W74	\$280	+\$35
8PP Accordion Fold + 8PP Accordion Fold (H)		L105 x W74	\$280	+\$35
10PP Accordion Fold + 8PP Accordion Fold (H)		L84 x W74	\$360	+\$35
6PP Accordion Fold + 10PP Accordion Fold (H)		L140 x W59	\$360	+\$35
8PP Accordion Fold + 10PP Accordion Fold (H)		L105 x W59	\$360	+\$35
Special Half-Fold + 8PP Accordion Fold		L297 x W70	\$240	+\$35
Special Half-Fold + 10PP Accordion Fold		L297 x W60	\$280	+\$35

Folding services above are limited to paper material (80-128g paper)

Note: Please be aware that all the prices are subject to change without prior notice, please visit our website for the latest updates

## Finishing Items

### Folding

Style	Available Size	Completed Size	First 1,000 pcs	Additional for every 1,000 pcs
Half-Fold	A6 (L148 x W105)	L74 x 105 W52 x 148	\$50	+\$25
	A5 (L210 x W148)	L105 x 148 W74 x 210		
	A4 (L297 x W210)	L148 x 210 W105 x 297		
Letter Fold 6PP Accordion Fold	A5 (L210 x W148)	L70 x 148	\$70	+\$25
	A4 (L297 x W210)	L99 x 210 W70 x 297		
8PP Roll Fold 8PP Accordion Fold	A5 (L210 x W148)	L52 x 148	\$90	+\$25
	A4 (L297 x W210)	L74 x 210 W52 x 297		
10PP Accordion Fold	A4 (L297 x W210)	L210 x 59	\$110	+\$25
Gatefold	A4 (L297 x W210)	L148 x 210	\$70	+\$25
Double Gatefold	A4 (L297 x W210)	L74 x 210	\$90	+\$25
Double Parallel-Fold	A4 (L297 x W210)	L74 x 210	\$90	+\$25
Crossfold	A5 (L210 x W148)	L105 x 74	\$70	+\$25
	A4 (L297 x W210)	148 x 105		
Letter Fold + Half-Fold	A4 (L297 x W210)	L99 x 105	\$90	+\$25
8PP Roll Fold + Half-Fold 8PP Accordion Fold + Half-Fold	A4 (L297 x W210)	L105 x 74	\$110	+\$25
Crossfold With 3 Edges Trimmed	A4 (L297 x W210)	L148 x 105	\$110	+\$35

Folding services above are limited to paper material (80-157g paper)

**Lead Time:** + 1 working day (Less than 10,000 pcs)

Note: Please be aware that all the prices are subject to change without prior notice, please visit our website for the latest updates

### Samples of Folding

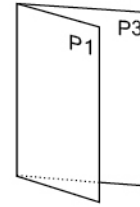

Half-Fold  
(2 Panels / 4PP)

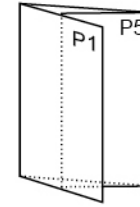

Letter Fold  
(3 Panels / 6PP)

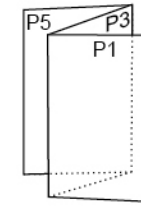

6PP Accordion Fold  
(3 Panels / 6PP)

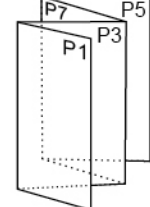

8PP Accordion Fold  
(4 Panels / 8PP)

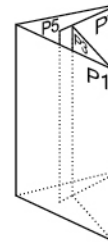

Double Gatefold

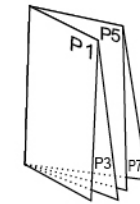

Crossfold

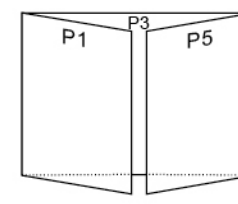

Gatefold

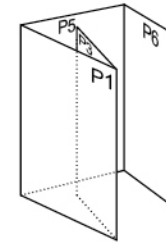

Roll Fold



Half-Fold +  
8PP Accordion Fold (H)

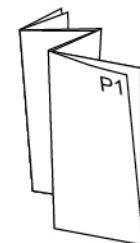

6PP Accordion Fold +  
8PP Accordion Fold

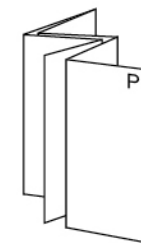

Special Half-Fold +  
8PP Accordion Fold

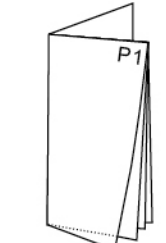

Letter Fold + Crossfold

\* For more artwork specifications, please visit our website [www.e-print.com.hk](http://www.e-print.com.hk)

#### Special Folding Offer:

Enjoy HK\$20 "Special Folding Offer" by fulfilling the following requirements:

1. Within A4 size;
2. 80g to 157g paper (Excluded creasing line);
3. Any folding layout within 2 fold;
4. Folded goods must be printed by e-print;
5. This offer cannot be used with other discounts;
6. e-print reserves the rights and withholds final decision over the discount premium.

\* Prices of other sizes and folding methods are remained unchanged. For any enquiries, please contact us at 2344 6668.

## Print Matter Sealing

No. of Label Qty.	1 Label	2 Labels	3 Labels
1,000 pcs	\$70	\$140	\$210
2,000 pcs	\$140	\$280	\$420
3,000 pcs	\$210	\$420	\$630
4,000 pcs	\$280	\$560	\$840
5,000 pcs	\$350	\$700	\$1,050
6,000 pcs	\$420	\$840	\$1,260
7,000 pcs	\$490	\$980	\$1,470
8,000 pcs	\$560	\$1,120	\$1,680
9,000 pcs	\$630	\$1,260	\$1,890
10,000 pcs	\$700	\$1,400	\$2,100

- This service can only apply to Leaflets and Saddle Stitching Booklet, if the booklet requires more than one label or 32PP, the sealing fee will be quoted by specialized follow-up staff
- 25 x 25mm transparent round sticker will be used for sealing up the printed matter
- The folded leaflets must be square or rectangular in shape
- The sticker will be sealed on the middle of sealing edge, if customers have special requirement on the position of label, please provide a file with the expected position
- Thickness of finished products must not exceed 10mm
- Finished products will be packed in bundles of 100pcs
- Customer can also choose **Circular Posting Service**, our company adopts Hong Kong Post Circular Service, additional service fees will be charged for transportation and administration costs. The above fee will be quoted by specialized follow-up staff

**Lead Time: Print Matter Sealing Service + 1-2 working days**  
(Depends on that day's order quantity)  
\* Collecting from branches + 1 working day  
**Circular Posting Service (Depends on Post Office)**

Note: Please be aware that all the prices are subject to change without prior notice, please visit our website for the latest updates

## Finishing Items

### Numbering

No. Qty.	1 No.	2 No.	3 No.	4 No.	5 No.	6 No.	7 No.	8 No.
1,000	\$80	\$100	\$120	\$140	\$160	\$180	\$200	\$220
2,000	\$150	\$170	\$190	\$210	\$230	\$250	\$270	\$290
3,000	\$220	\$240	\$260	\$280	\$300	\$320	\$340	\$360
4,000	\$290	\$310	\$330	\$350	\$370	\$390	\$410	\$430
5,000	\$360	\$380	\$400	\$420	\$440	\$460	\$480	\$500

- Same prices are imposed on both thick / thin paper material
- Maximum size of paper used for numbering is 570 x 393mm and non-numbering is 330 x 228mm
- Please indicate the colour and size of numbering  
(\*"No." and numbers are in the same colour, digits for numbers are with 4-6)

**Lead Time: + 1 working day (Depends on quantity)**

### Perforation, Creasing

Type Qty.	1 line	2 lines	3 lines	4 lines	5 lines	6 lines	Single direction (within A4)	Multi-direction (within A4)	Single direction (within 23x16")	Multi-direction (within 23x16")
1,000	\$90	\$100	\$120	\$140	\$160	\$180	\$220	\$320	\$370	\$470
2,000	\$160	\$170	\$190	\$210	\$230	\$250	\$290	\$390	\$440	\$540
3,000	\$230	\$240	\$260	\$280	\$300	\$320	\$360	\$460	\$510	\$610
4,000	\$300	\$310	\$330	\$350	\$370	\$390	\$430	\$530	\$580	\$680
5,000	\$370	\$380	\$400	\$420	\$440	\$460	\$500	\$600	\$650	\$750

- Maximum size for perforation / creasing is 571.5 x 431.8mm
- Straight + Horizontal perforation / creasing or more than 6 lines are determined by according die-cutter

**Lead Time: + 1 working day (Depends on quantity)**

Note: Please be aware that all the prices are subject to change without prior notice, please visit our website for the latest updates

## Foil Stamping

Stamping Area Qty.	20 x 20mm	50 x 40mm	90 x 50mm	90 x 110mm	90 x 150mm	190 x 150mm	200 x 280mm	400 x 280mm
100	\$30	\$40	\$75	\$130	\$160	\$300	—	—
200	\$45	\$60	\$105	\$180	\$220	\$370	—	—
300	\$60	\$80	\$135	\$230	\$280	\$440	—	—
400	\$75	\$100	\$165	\$280	\$340	\$510	—	—
500	\$90	\$120	\$195	\$330	\$400	\$580	\$830	\$1,760
600	\$105	\$140	\$225	\$380	\$460	\$650	\$970	\$1,890
700	\$120	\$160	\$255	\$430	\$520	\$720	\$990	\$2,020
800	\$135	\$180	\$285	\$480	\$580	\$790	\$1,070	\$2,150
900	\$155	\$200	\$315	\$530	\$640	\$860	\$1,150	\$2,280
1,000	\$170	\$220	\$345	\$580	\$700	\$930	\$1,230	\$2,410
2,000	\$310	\$420	\$620	\$1,040	\$1,190	\$1,500	\$1,870	\$3,450
3,000	\$430	\$560	\$850	\$1,410	\$1,690	\$1,970	\$2,470	\$4,420
4,000	\$530	\$710	\$1,060	\$1,760	\$2,120	\$2,460	\$2,990	\$5,270
5,000	\$650	\$860	\$1,290	\$2,150	\$2,580	\$3,000	\$3,550	\$6,180

- Maximum and minimum sizes of paper used are 420 x 297mm and 90 x 54mm respectively
- Maximum foiling area is 400 x 280mm; prices of both thick and thin paper are the same
- Colours of foiling are gold, silver, metallic red and metallic green  
(For other nominated colour, minimum order quantity is 1,000 pcs)
- Artwork of Foil Stamping can accept vector image for draft only, screening line will not be accepted
- Engraving plate of Foil Stamping will not be returned to customers

**Lead Time: + 2 working days**

\* Collecting from branches + 1 working day

Note: Please be aware that all the prices are subject to change without prior notice, please visit our website for the latest updates

## Finishing Items

### Spot UV

Print Area Qty.	279 x 355mm – 420 x 594mm	279 x 355mm – 420 x 594mm	420 x 594mm – 508 x 700mm	420 x 594mm – 508 x 700mm
Area	UV Area within 200 x 400mm	UV Area above 200 x 400mm	UV Area within 400 x 400mm	UV Area above 400 x 400mm
1,000	\$700	\$750	\$980	\$1,050
2,000	\$1,100	\$1,200	\$1,540	\$1,680
3,000	\$1,500	\$1,650	\$2,100	\$2,310
4,000	\$1,900	\$2,100	\$2,660	\$2,940
5,000	\$2,300	\$2,550	\$3,220	\$3,570
20,000	\$8,300	\$9,300	\$11,620	\$13,020
30,000	\$12,300	\$13,800	\$17,220	\$19,320
40,000	\$16,300	\$18,300	\$22,820	\$25,620
50,000	\$20,300	\$22,800	\$28,420	\$31,920

- Maximum and minimum sizes of paper used are 508 x 700mm and 279 x 355mm respectively
- Prices of customers' own film for making the plate, both thick and thin paper are the same
- Please seek for quotation for other special request

**Lead Time: + 1 working day (Spot UV)**

+ 2 working days (Double-sided Spot UV)

### Pad

Qty.	Type	Pad	Staple	Qty.	Type	Pad	Staple
20 pcs		\$30	\$40	200 pcs		\$140	\$160
30 pcs		\$42	\$50	300 pcs		\$180	\$210
40 pcs		\$52	\$60	400 pcs		\$200	\$240
50 pcs		\$60	\$70	500 pcs		\$250	\$300
60 pcs		\$66	\$80	600 pcs		\$300	\$360
70 pcs		\$70	\$85	700 pcs		\$350	\$420
80 pcs		\$74	\$90	800 pcs		\$400	\$480
90 pcs		\$77	\$95	900 pcs		\$450	\$540
100 pcs		\$80	\$100	1,000 pcs		\$500	\$600

**Lead Time: + 1 working day (Depends on quantity)**

Note: Please be aware that all the prices are subject to change without prior notice, please visit our website for the latest updates

## Round Cornering

Qty.	Price	Qty.	Price
100	\$5	800	\$40
200	\$10	900	\$45
300	\$15	1,000	\$50
400	\$20	2,000	\$80
500	\$25	3,000	\$120
600	\$30	4,000	\$160
700	\$35	5,000	\$200

· Round Cornering will only be processed for finished goods (Cutting excluded), size must be within A4

**Lead Time:** + 1 working day (Depends on the number of ordering)

## Hole Drilling

Qty.	1 hole	2 holes	3 holes	4 holes	Qty.	1 hole	2 holes	3 holes	4 holes
100	\$10	\$13	\$16	\$19	800	\$31	\$41	\$51	\$61
200	\$13	\$17	\$21	\$25	900	\$34	\$45	\$56	\$67
300	\$16	\$21	\$26	\$31	1,000	\$37	\$49	\$61	\$73
400	\$19	\$25	\$31	\$37	2,000	\$67	\$89	\$111	\$133
500	\$22	\$29	\$36	\$43	3,000	\$97	\$129	\$161	\$193
600	\$25	\$33	\$41	\$49	4,000	\$127	\$169	\$211	\$253
700	\$28	\$37	\$46	\$55	5,000	\$157	\$209	\$261	\$313

- Diameter of Hole: 2.5mm / 3mm / 4mm / 5.5mm / 6mm / 8mm
- Size of paper used is within 297 x 420mm
- Hole drilling will only be processed for finished goods (Cutting excluded), for booklet via Hole drilling, each 2 booklets are equivalent to 100 pcs
- All NCR invoice booklet via 2 holes drilling, average price will be \$1 each

**Lead Time:** + 1 working day (Depends on quantity)

Note: Please be aware that all the prices are subject to change without prior notice, please visit our website for the latest updates

## Finishing Items

### Embossing

Embossing Area Qty.	20 x 20mm	50 x 40mm	90 x 50mm	90 x 110mm	90 x 150mm	190 x 150mm	200 x 280mm	400 x 280mm
100	\$60	\$70	\$105	\$180	\$240	\$460	—	—
200	\$75	\$90	\$135	\$230	\$300	\$530	—	—
300	\$90	\$110	\$165	\$280	\$360	\$600	—	—
400	\$105	\$130	\$195	\$330	\$420	\$670	—	—
500	\$120	\$150	\$225	\$380	\$480	\$740	\$1,130	\$1,950
600	\$135	\$170	\$255	\$430	\$540	\$810	\$1,270	\$2,050
700	\$150	\$190	\$285	\$480	\$600	\$880	\$1,290	\$2,150
800	\$165	\$210	\$315	\$530	\$660	\$950	\$1,370	\$2,250
900	\$185	\$230	\$345	\$580	\$720	\$1,020	\$1,450	\$2,350
1,000	\$200	\$250	\$375	\$630	\$780	\$1,090	\$1,530	\$2,450
2,000	\$340	\$450	\$650	\$1,090	\$1,270	\$1,660	\$2,170	\$3,250
3,000	\$460	\$590	\$880	\$1,460	\$1,770	\$2,130	\$2,770	\$4,000
4,000	\$560	\$740	\$1,090	\$1,820	\$2,200	\$2,620	\$3,290	\$4,650
5,000	\$680	\$890	\$1,320	\$2,200	\$2,660	\$3,160	\$3,850	\$5,350

- Maximum size of paper is 420 x 297mm; prices of both thick and thin paper are the same
- Maximum embossing area is 400 x 280mm
- Artwork of embossing can accept vector image for draft only, screening line will not be accepted
- Engraving plate of embossing will not be returned to customers

**Lead Time:** + 2 working days

\* Collecting from branches + 1 working day

Note: Please be aware that all the prices are subject to change without prior notice, please visit our website for the latest updates



# 自助平臺

SELF-SERVICE PLATFORM



24 HOURS ONLINE ORDER  
24小時網上落單

快捷  
即時報價  
EASY

方便  
網上落單  
CONVENIENT

可靠  
在線查詢  
SECURE

安全  
網上付款  
SAFE

印刷、噴畫網上訂購 習慣從此改變!  
Easy Online Ordering, Convenient In-store Pickup!

[www.e-print.com.hk](http://www.e-print.com.hk)

[www.e-banner.com](http://www.e-banner.com)



Leaflet

Business Card

Posters

Notebook

Labels/ Sticker

Digital printing

Coupons/ Tickets

Letterheads

Photobook 1010



PHOTOBOOK1010  
[www.photobook1010.com](http://www.photobook1010.com)

e-print

For enquiries, please e-mail us to [marketing01@e-print.com.hk](mailto:marketing01@e-print.com.hk)

# Welcome for your printing quotation

# Battle



**2319 7223**

quote\_exp@e-print.com.hk

Favourable Price for Bulk Printing

**Bulk Print  
Quotation**



**2319 7222**

quote@e-print.com.hk

**General  
Quotation**



SMS Express (Mobile Phone Only)

**9148 6667**

Customer Service Hotline

**2344 6668**

[www.e-print.com.hk](http://www.e-print.com.hk)



e-print

**24 HOURS**  
PRINTING SERVICES

**www.e-print.com.hk**

HQ

**KWUN TONG SHOP • Tel: 2319 7001 • Fax: 2344 6618**

Shop B, G/F, Phase 4, Kwun Tong Industrial Centre, No.436-446 Kwun Tong Rd., Kwun Tong, Kln. (MTR Kwun Tong Station Exit D4)

HK  
Island

**WAN CHAI SHOP • Tel: 2319 7002 • Fax: 2344 6617**

G/F., No.183 Hennessy Rd., Wan Chai, H.K. (MTR Wan Chai Station Exit A2)

**SHEUNG WAN SHOP • Tel: 2319 7008 • Fax: 2581 3117**

Portion A, G/F., Harbour Commercial Building, No.122-124 Connaught Road, Central, H.K.

**CHAI WAN SHOP • Tel: 2319 7003 • Fax: 2505 0661**

Shop 1A, G/F., Trend Centre, No.29 Cheung Lee St., Chai Wan, H.K.

**QUARRY BAY SHOP • Tel: 2319 7019 • Fax: 2321 3130**

G/F., Tor Po Mansion, No.24 Hoi Kwong Street, Quarry Bay, H.K.

Kowloon

**MONG KOK SHOP • Tel: 2319 7016 • Fax: 2343 3698**

Shop 19, G/F., Tak Po Building, No. 81 Hak Po St., Mongkok, Kln.

**HUNG HOM SHOP • Tel: 2319 7011 • Fax: 2333 7255**

Shop CD5(A), G/F., Hang Fung Industrial Building, Phase 1, No.2G Hok Yuen St., Hung Hom, Kln.

**SHAM SHUI PO SHOP • Tel: 2319 7009 • Fax: 2720 6610**

Shop 6 & 7B, G/F., Wing Yip Commercial Building, No. 65-71 Yen Chow St., Sham Shui Po, Kln

**SAN PO KONG SHOP • Tel: 2319 7018 • Fax: 2453 4288**

Shop F, G/F., Wealth Court, 98 Tseuk Luk Street, San Po Kong, Kln.

New  
Territories

**KWAI HING SHOP • Tel: 2319 7004 • Fax: 2344 4646**

Shop A-9, G/F., Kwai Chung Centre Arcade, No.102 Kwai Hing Rd., Kwai Chung, N.T. (MTR Kwai Hing Station Exit A)

**TSUEN WAN SHOP • Tel: 2319 7007 • Fax: 2499 7500**

Shop 5A, G/F., Cheong Lock Building, No.100 Sai Lau Kok Rd., Tsuen Wan, N.T. (MTR Tsuen Wan Station Exit A1)

**YUEN LONG SHOP • Tel: 2319 7006 • Fax: 2443 2117**

Shop 13B, G/F., Siu Fung Building, No.68 Kau Yuk Rd., Yuen Long, N.T.

Malaysia

e-print Solution Sdn Bhd [www.e-print.my](http://www.e-print.my)

**PUDU SHOP • Tel: 03-2142 9300**

**SERDANG BRANCH SHOP • Tel: 03-8948 1900**

**KIP SHOP • Tel: 016-211 1091**

**KLANG SHOP • Tel: 016-220 8300**

**SALAK SELATAN SHOP • Tel: 03-7981 9300**

**TAMAN MELAWATI SHOP • Tel: 03-4106 9300**

**DAMANSARA JAYA SHOP • Tel: 03-7733 9935**

**TAMAN SRI TEBRAU SHOP • Tel: 07-331 2993**

SMS Express (Mobile Phone Only)

Customer Service Hotline

**9148 6667 | 2344 6668**

[globalsales@e-print.com.hk](mailto:globalsales@e-print.com.hk)